

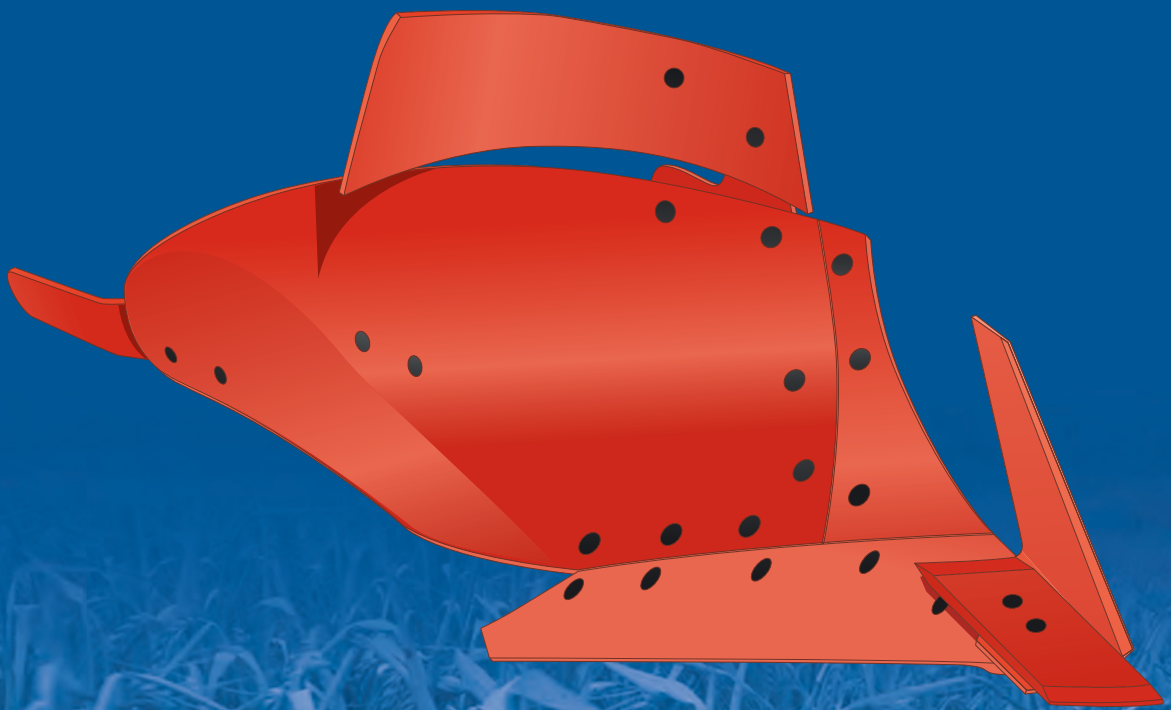

Made for hard work



Catalogue



Made for hard work

**Welcome to Mølbro.
We are proud to present our wide ranging program of tillage
tools and hope you will be inspired by our new catalogue.**

www.molbro.com

Print 01/2015

Table of contents catalogue



Plough parts

Wearing parts to fit:

AGROLUX AH ploughbody	5
AGROLUX AS ploughbody	6
AGROLUX AX ploughbody	7
AGROLUX FC ploughbody	8
AGROLUX FK ploughbody	9
AGROLUX KHN ploughbody	10
AGROLUX KH ploughbody	10
AGROLUX L, P og PP ploughbodies	10
AGROLUX ploughs	11
DURO ploughbodies	11
DOWDESWELL DD ploughbody	12
DOWDESWELL RCN, SCN, og UCN ploughbodies	13
FORTSCHRITT 30Z og 30ZS ploughbodies	14
FRAUGDE CAX and FK ploughbodies	15
FRAUGDE FA ploughbody	16
FRAUGDE FA and FKA ploughbodies	17
FRAUGDE FS and GS ploughbodies	18
FRAUGDE MS ploughbody	19
FRAUGDE 208 ploughbody	20
FRAUGDE plough	21
GOIZIN plough	22
GREGOIRE-BESSON plough	23
KRONE KG ploughs	52
KUHN RH/RLM ploughbodies, PP and C ploughbodies	24
KUHN H4 and H6 ploughbodies	25
KUHN Hb4 and HB6 ploughbodies	26
KUHN SK ploughbody	27
KUHN VL ploughbody	28
KUHN VS/N ploughbodies, ploughs	29
KVERNELAND ploughbody nr. 3	30
KVERNELAND ploughbody nr. 6, 7, 8, 9 og 28	31,32
KVERNELAND ploughbody nr. 12 og 19	33,34
KVERNELAND ploughbody nr. 20 og 30	35,36
KVERNELAND ploughbody 53-serien	36
KVERNELAND ploughbody ECOMAT	37
KVERNELAND ploughs	38
LEMKEN B ploughbody	39
LEMKEN BS 40 ploughbody	40
LEMKEN BS 42 ploughbody	41
LEMKEN BU ploughbody	42
LEMKEN DURAMAXX ploughbody	42
LEMKEN C and C40 ploughbodies	43
LEMKEN US 35 ploughbody	44
LEMKEN US 40 ploughbody	45
LEMKEN WG-WS ploughbodies	46
LEMKEN ploughs	42
MASSEY-FERGUSON FC ploughbody	47
MASSEY-FERGUSON AH ploughbody	48
MASSEY-FERGUSON AS ploughbody	49
MASSEY-FERGUSON AX ploughbody	50
MASSEY-FERGUSON FK ploughbody	51
MASSEY-FERGUSON ploughs	52
NAUD ploughs	53
NIEMEYER ploughs	53
PÖTTINGER ploughbodies 36W/41W	54
PÖTTINGER ploughbody 46W	55
RABE ploughbodies BP-321, 322, 323 PS/PSL	56
RABE ploughbodies BP-350 WS/WSL	57
RABE ploughbodies BP-2930, 2940 L	58
RABE universal ploughs	59
RABE universal ploughbodies (Lemken)	60
ROSS/Roudnice nad Labem ploughs	61
UNIA ploughbodies	62
VOGEL & NOOT ploughbody UN 400, ploughs	63
VOGEL & NOOT ploughbody WY 400	64
ØVERUM SR ploughbody	65
ØVERUM XU ploughbody	66
ØVERUM V ploughbody	67
ØVERUM XL ploughbody	68
ØVERUM XS ploughbody	69
ØVERUM XU ploughbody, ploughs	70
ØVERUM SM, SML and SMK ploughbody	71

Subsoiler parts

Wearing parts to fit:

KVERNELAND Subsoiler "S"	72
KVERNELAND AGROMAT, Bonator Subsoiler	73
Standard Harrows	73, 74
Standard Discs	74, 75
HORSCH Harrows	76, 77
BOURGAULT Harrows	77
KERNER Harrows	78
KÖCKERLING Harrows	78
LEMKEN Harrows, KOMPAKTOR Harrows	79, 80
LEMKEN Drilling machine	80
VÄDERSTAD Drilling machine	81
VÄDERSTAD Harrows	82

EUROCARBIDE Wearing parts ploughs

Wearing parts to fit:

AGROLUX, FORTSCHRITT FRAUGDE	83
GREGOIRE-BESSON, KUHN	83
KVERNELAND	84
LEMKEN	85
MASSEY-FERGUSON, RABE, ROSS, ØVERUM	86

EUROCARBIDE Wearing parts subsoiler

Wearing parts to fit:

HORSCH	87
KERNER	87
KVERNELAND	87
KÖCKERLING	87
LEMKEN	88
STANDARD HARROWS	88
VÄDERSTAD	88

Disc coultter and accessories

Wearing parts to fit:

KVERNELAND	75, 89
VÄDERSTAD	90
ØVERUM	90

Information

MØLBRO Bolts and Nuts - BK system	91
MØLBRO www.molbro.com	92

© Copyright MØLBRO 2012
EUROSHARE®Reg. trade mark. Reg. design.
EUROPOINT®Reg. trade mark. Reg. design
MØLBRO ®
MØLBRO M7-points and MØLBRO M7-adapters are covered by US patent no.8875424





Bolts and nuts are now sold separately in bolt boxes (BK no).

Here is our new Bolt box no. added to our catalogue, this makes it easy to find the right Bolt box no. for the Article no. when you order your parts. See page 80 in our catalogue for more information.

Parts to fit

LEMKEN BS 42 ploughbodies

Mouldboards, shins and accessories

		<u>Bolt box no.</u>	<u>Article-no.</u>	<u>Designation</u>
567MOL	3470860	BK009	3470860	Turbo-trashboard R
568MOL	3470861	BK009	3470861	Turbo-trashboard L
469MOL-R	3444030	BK141	469MOL-R	Stay with support R
469MOL-L	3444031	BK141	469MOL-L	Stay with support L
4695600	3444020		4695600	Stay R
4695601	3444021		4695601	Stay L
4671002	3444010		567MOL	Support for stay, short
4671003	3444011		568MOL	Support for stay, long
	3444012	BK007	3451002	Shin R (10mm)
	3444013			
	3444042	BK007	3451003	Shin L (10mm)
	3444043			
	3451002	BK010	3451010	Shin R (8mm)
	3451003	BK010	3451011	Shin L (8mm)
	3451010	BK172	3444010	Mouldboard stripe R
	3451011	BK172	3444011	Mouldboard stripe L
		BK172	3444020	Mouldboard stripe R
		BK172	3444021	Mouldboard stripe L
		BK172	3444030	Mouldboard stripe R
		BK172	3444031	Mouldboard stripe L
		BK173	3444042	Mouldboard stripe R
		BK173	3444043	Mouldboard stripe L
		BK006	3444012	Rev. top stripe R
		BK006	3444013	Rev. top stripe L
		BK140	4671002	Frog R
		BK140	4671003	Frog L

Parts to fit

AGROLUX AH ploughbody

	Bolt box no.	Article-no.	Designation
Mouldboards, shins and accessories			
	BK082	74922	Mouldboard extension R
	BK082	80559	Mouldboard extension L
		96064/83969	Turbo-trashboard R
		96065/83968	Turbo-trashboard L
	BK082	94624	Fittings for trashboard R
	BK082	94625	Fittings for trashboard L
	BK067	96084	Mouldboard R
	BK067	96085	Mouldboard L
	BK052	96086	Shin R
	BK052	96087	Shin L
Shares and points			
	BK052	96090	Share 16" R
	BK052	96091	Share 16" L
	BK052	96092	Share 18" R
	BK052	96093	Share 18" L
	BK031	94610	Europoint R
	BK031	94611	Europoint L
	BK031	MOL612	M7-Adapter R
	BK031	MOL613	M7-Adapter L
		MOL83	M7 point rev. R/L
		4879058	Wegde for M7 point
Landsides and share knives			
	BK069	96094	Landside R
	BK069	96095	Landside L
	BK084	94622	Share knife R
	BK084	94623	Share knife L
Parts to mount on landsides			
	BK094	63600A	Wearig plate, rev. R&L
	BK094	63601A	Wearing plate, rev. R&L
	BK052	1349408	Sword coulter R
	BK052	1349409	Sword coulter L
	BK096	800MOL	Subsoiler blade R
	BK096	801MOL	Subsoiler blade L

Parts to fit

AGROLUX AS ploughbody

Bolt box no. Article-no. Designation

Mouldboards, shins and accessories

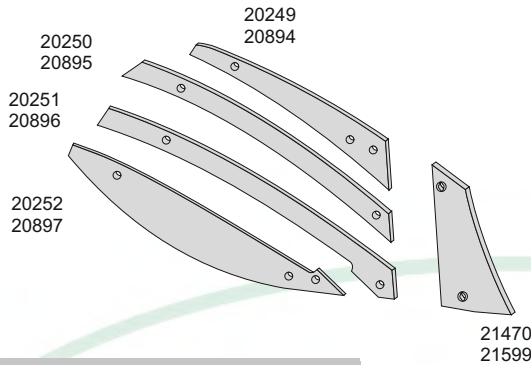

BK058	20249	Mouldboard stripe R
BK058	20894	Mouldboard stripe L
BK052	20250	Mouldboard stripe R
BK052	20895	Mouldboard stripe L
BK052	20251	Mouldboard stripe R
BK052	20896	Mouldboard stripe L
BK058	20252	Mouldboard stripe R
BK058	20897	Mouldboard stripe L
BK052	21470	Shin R
BK052	21599	Shin L

Shares and points

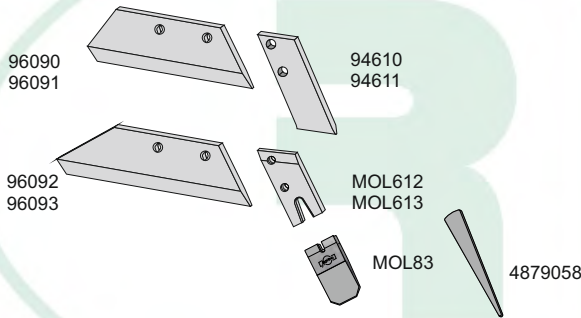

BK052	96090	Share 16" R
BK052	96091	Share 16" L
BK052	96092	Share 18" R
BK052	96093	Share 18" L
BK031	94610	Europoint R
BK031	94611	Europoint L
BK031	MOL612	M7-Adapter R
BK031	MOL613	M7-Adapter L
	MOL83	M7 point rev. R/L
	4879058	Wegde for M7 point

Landsides and share knives

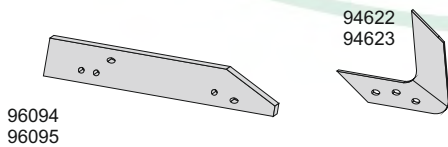

BK069	96094	Landside R
BK069	96095	Landside L
BK084	94622	Share knife R
BK084	94623	Share knife L

Parts to mount on landsides

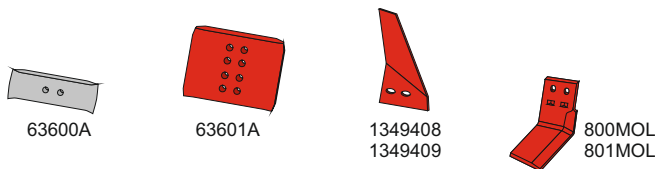











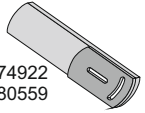





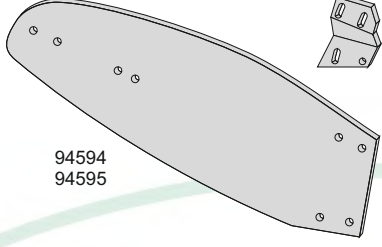
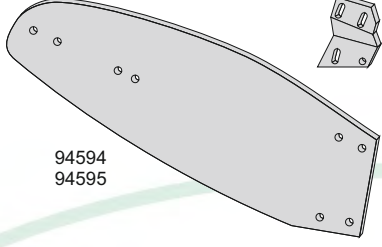

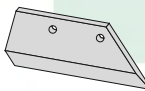

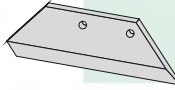

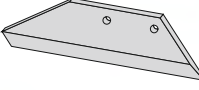



BK094	63600A	Wearing plate, rev. R&L
BK094	63601A	Wearing plate, rev. R&L
BK052	1349408	Sword coultter R
BK052	1349409	Sword coultter L
BK096	800MOL	Subsoiler blade R
BK096	801MOL	Subsoiler blade L

Did you know...

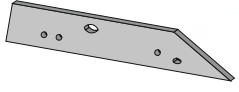
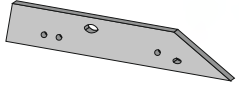
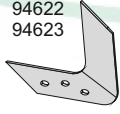
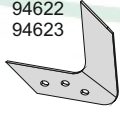
that your landsides will last 3-4 times longer if you use Mølbros wearing plate 63600A or 63601A.

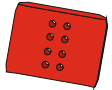







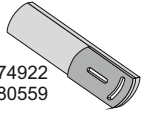

Parts to fit

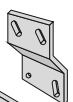
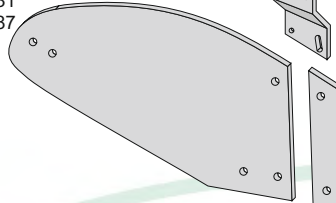
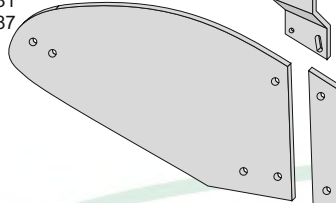
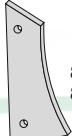
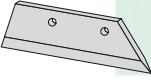
AGROLUX AX ploughbody

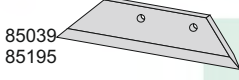
	<u>Bolt box no.</u>	<u>Article-no.</u>	<u>Designation</u>
Mouldboards, shins and accessories			
		74922 80559	
	BK082	74922	Mouldboard extension R
	BK082	80559	Mouldboard extension L
	BK167	96064	Turbo-trashboard R
	BK167	96065	Turbo-trashboard L
	BK082	94624	Fittings for trashboard R
	BK082	94625	Fittings for trashboard L
	BK066	94594	Mouldboard R
	BK066	94595	Mouldboard L
	BK052	94596	Shin R
	BK052	94597	Shin L
Shares and points			
	BK052	94598	Share 14" R
	BK052	94599	Share 14" L
	BK052	94600	Share 16" R
	BK052	94601	Share 16" L
	BK052	94602	Share 18" R
	BK052	94603	Share 18" L
	BK031	94610	Europoint R
	BK031	94611	Europoint L
	BK031	MOL612	M7-Adapter R
	BK031	MOL613	M7-Adapter L
	BK031	MOL83	M7 point rev. R/L
	BK031	4879058	Wedge for M7 point
Landsides and share knives			
	BK074	94606	Landside R
	BK074	94607	Landside L
	BK084	94622	Share knife R
	BK084	94623	Share knife L
Parts to mount on landsides			
	BK094	63600A	Wearing plate, rev. R&L
	BK094	63601A	Wearing plate, rev. R&L
	BK052	1349408	Sword coulter R
	BK052	1349409	Sword coulter L
	BK096	800MOL	Subsoiler blade R
	BK096	801MOL	Subsoiler blade L

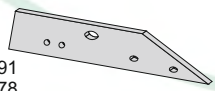
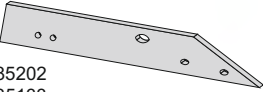
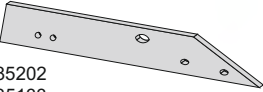
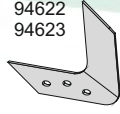







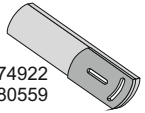

Parts to fit

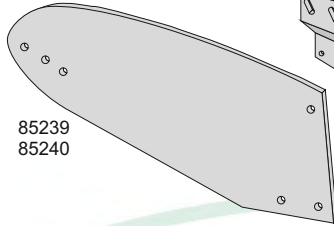
AGROLUX FC ploughbody

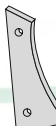
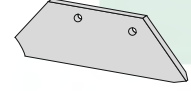
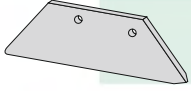
	Bolt box no.	Article-no.	Designation
Mouldboards, shins and accessories			
		74922 80559	
	BK167	83969	Turbo-trashboard R
	BK167	83968	Turbo-trashboard L
		84022	Fittings for trashboard R
		84023	Fittings for trashboard L
	BK082	74922	Mouldboard extension R
	BK082	80559	Mouldboard extension L
	BK062	84031	Mouldboard R
	BK062	84087	Mouldboard L
	BK065	84033	Shin R
	BK065	84082	Shin L
Shares and points			
	BK052	85004	Share 16" R
	BK052	85194	Share 16" L
	BK052	85039	Share 18" R
	BK052	85195	Share 18" L
	BK031	84987C	EUROCARBIDE M5 point R
	BK031	85206C	EUROCARBIDE M5 point L
	BK031	84987	Europoint R
	BK031	85206	Europoint L
Landsides and share knives			
	BK084	94622	Share knife R
	BK084	94623	Share knife L
	BK073	86291	Landside, short R
	BK073	85578	Landside, short L
	BK073	85202	Landside, long R
	BK073	85133	Landside, long L
		94622 94623	
Parts to mount on landsides			
	BK094	63600A	Wearing plate, rev. R&L
	BK094	63601A	Wearing plate, rev. R&L
	BK052	1349408	Sword coulter R
	BK052	1349409	Sword coulter L
	BK096	800MOL	Subsoiler blade R
	BK096	801MOL	Subsoiler blade L
		800MOL 801MOL	

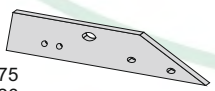
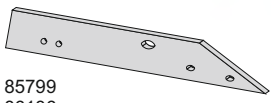
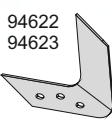
Parts to fit

AGROLUX FK ploughbody

		<u>Bolt box no.</u>	<u>Article-no.</u>	<u>Designation</u>
Mouldboards, shins and accessories				
	74922 80559			
	83969 83968	BK167	83969	Turbo-trashboard R
		BK167	83968	Turbo-trashboard L
	85239 85240	BK063	85239	Mouldboard R
		BK063	85240	Mouldboard L
	84022 84023	BK082	74922	Mouldboard extension R
		BK082	80559	Mouldboard extension L
	83980 84083	BK065	83980	Shin R
		BK065	84083	Shin L
Shares and points				
	85383 85381	BK052	85383	Share 16" R
		BK052	85381	Share 16" L
	85384 85382	BK052	85384	Share 18" R
		BK052	85382	Share 18" L
	84942 85204	BK031	84942	Europoint R
		BK031	85204	Europoint L
Landsides and share knives				
	85675 86126	BK084	94622	Share knife R
		BK084	94623	Share knife L
	85799 86136	BK073	85675	Landside, short R
		BK073	86126	Landside, short L
	94622 94623	BK073	85799	Landside, long R
		BK073	86136	Landside, long L
Parts to mount on landsides				
	63600A	BK094	63600A	Wearing plate, rev. R&L
	63601A	BK094	63601A	Wearing plate, rev. R&L
	1349408 1349409	BK052	1349408	Sword coulter R
		BK052	1349409	Sword coulter L
	800MOL 801MOL	BK096	800MOL	Subsoiler blade R
		BK096	801MOL	Subsoiler blade L

Parts to fit

AGROLUX KHN ploughbody

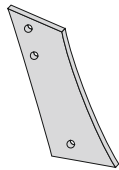
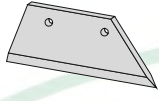
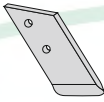
	Bolt box no.	Article-no.	Designation
Shins			
 950025-05 950041-13	BK121	950025-05	Shin-R
	BK121	950041-13	Shin-L
Shares and points			
 950024-89 950041-20	BK119	950024-89	Share 16" H
	BK119	950041-20	Share 16" V
 950024-90 950041-18	BK119	950024-90	EUROPOINT R
	BK119	950041-18	EUROPOINT L

Parts to fit

AGROLUX KH poughbody

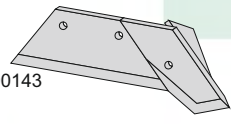
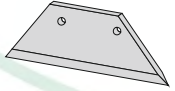
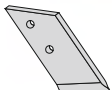

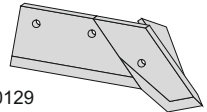

	Bolt box no.	Article-no.	Designation
Shares and points			
 91100143	BK121	91100143	Reinforced ploughshare 16" R
 950006-84	BK119	950006-84	Share 16" R
	BK119	950006-75	EUROPOINT R
 950006-75			

Parts to fit

AGROLUX L, P and PP ploughbody



	Bolt box no.	Article-no.	Designation
Shares and points			
 91100129	BK121	91100129	Reinforced ploughshare 16" R

Parts to mount on landsides

 63600A	 63601A	 1349408	 800MOL	BK094	63600A	Wearing plate, rev. R&L
				BK094	63601A	Wearing plate, rev. R&L
				BK052	1349408	Sword coulter R
				BK096	800MOL	Subsoiler blade R

Parts to fit

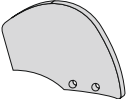
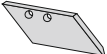
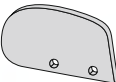
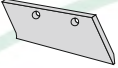
AGROLUX ploughs

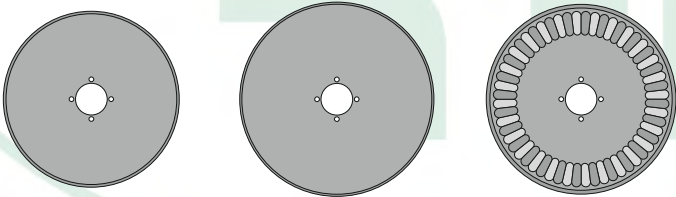
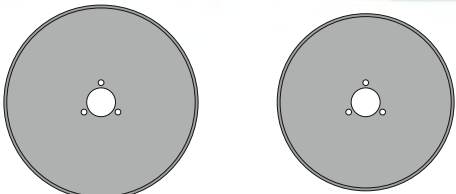
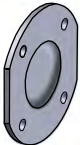
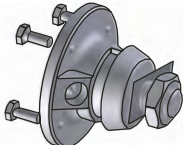
	Bolt box no.	Article-no.	Designation
Skim shares and skim mouldboards			
	BK003	80645	Skim mouldboard R
80645	BK052	91803	Skim mouldboard R
	BK052	91804	Skim mouldboard L
	BK050	80644	Skim share R
80644	BK052	91801	Skim share R
	BK052	91802	Skim share L
	BK052	93055	Skim share R
91803	BK052	93054	Skim share L
91804			
			
91801			
91802			
			
93055			
93054			
Disc coulters and accessories			
	72547		Disc coulters 18" R&L
72547	80662		Disc coulters 20" R&L
80662	80663		Disc coulters, rippled 20" R&L
80663	950004-74		Disc coulters 20" R&L
	950008-37		Disc coulters 18" R&L
	80967AH		Hub for disc coulters M30 R
	80967AV		Hub for disc coulters M30 L
950004-74	80966		Cover for disc coulters R&L
950008-37			
			
80966			
			
	80967AH		
	80967AV		

Parts to fit

DURO ploughbody

		<u>Bolt box no.</u>	<u>Article-no.</u>	<u>Designation</u>
Shares and points				
 6430 6429	 6432 6431	BK171	6430	EUROSHARE 16" R
		BK171	6429	EUROSHARE 16" L
		BK094	6432	Rev. Point R
		BK094	6431	Rev. Point L

Parts to fit

DOWDESWELL DD ploughbody











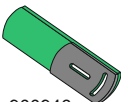

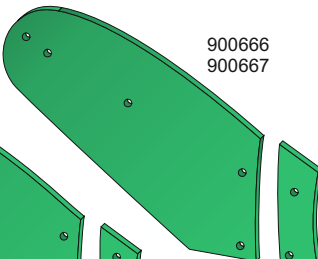
		<u>Bolt box no.</u>	<u>Article-no.</u>	<u>Designation</u>		
Shins						
 1136698 1136699		BK058	1136698	Shin R		
		BK099	1136699	Shin L		
Shares and points						
 1138398 1138399	 1176598 1176599	BK092	1138398	EUROSHARE 18" R		
		BK092	1138399	EUROSHARE 18" L		
		BK089	1176598	EUROPOINT rev. R		
		BK089	1176599	EUROPOINT rev. L		
 1161598 1161599	 901953 901954	 9053MOLC 9054MOLC	 114MOL R 114MOL L	BK092	1161598	EUROSHARE 16" R
				BK092	1161599	EUROSHARE 16" L
				BK090	901953	EUROPOINT w/b R
				BK090	901954	EUROPOINT w/b L
				BK095	9053MOLC	EUROCARBIDE M3 point R
				BK095	9054MOLC	EUROCARBIDE M3 point L
					114MOL R	Share knife R
					114MOL L	Share knife L

		<u>Bolt box no.</u>	<u>Article-no.</u>	<u>Designation</u>
Landsides				
 1137498 1137499	 1136700	BK091	1137498	Landside, long R
		BK091	1137499	Landside, long L
		BK090	1136700	Landside rev. R&L

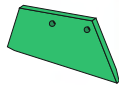
		<u>Bolt box no.</u>	<u>Article-no.</u>	<u>Designation</u>
Parts to mount on landsides				
 63600A	 63601A	BK094	63600A	Wearing plate, rev. R&L
		BK094	63601A	Wearing plate, rev. R&L
 1349408 1349409	 800MOL 801MOL	BK052	1349408	Sword coulter R
		BK052	1349409	Sword coulter L
		BK096	800MOL	Subsoiler blade R
		BK096	801MOL	Subsoiler blade L

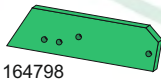
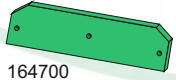
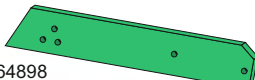
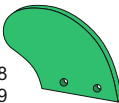
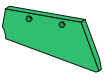





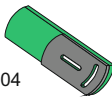
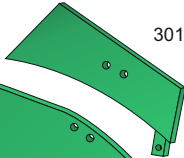
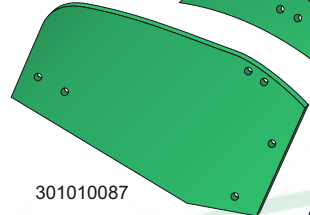
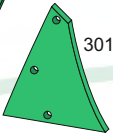
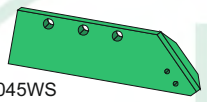

Parts to fit:

DOWDESWELL RCN, SCN, UCN ploughbodies

	<u>Bolt box no.</u>	<u>Article-no.</u>	<u>Designation</u>
Mouldboards, shins and accessories			
		900946	Mouldboard extension R
		900947	Mouldboard extension L
		900666	Mouldboard R, SCN
		900667	Mouldboard L, SCN
		900643	Mouldboard R, UCN
		900644	Mouldboard L, UCN
	900936	900936	Shin R, SCN
	900937	900937	Shin L, SCN
	BK069	900649	Shin R, UCN
	BK069	900650	Shin L, UCN
Shares and points			
	BK090	114788	Share R
	BK090	147899	Share L
	BK131	147298	Rev. point R
	BK131	147299	Rev. point L
Landsides			
	BK090	164798	Landside, short R
	BK090	16479998	Landside, short L
	BK090	164700	Landside, rev.R&L
	BK091	164898	Landside, long R
	BK091	164899	Landside, long L
Skim shares and skim mouldboards			
		048198	Skim mouldboard R
		048199	Skim mouldboard L
	BK027	048098	Skim share R
	BK027	048099	Skim share L
Parts to mount on landsides			
	BK094	63600A	Wearing plate, rev. R&L
	BK094	63601A	Wearing plate, rev. R&L
	BK052	1349408	Sword coulter R
	BK052	1349409	Sword coulter L
	BK096	800MOL	Subsoiler blade R
	BK096	801MOL	Subsoiler blade L

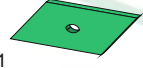
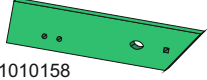
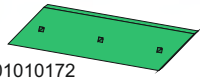
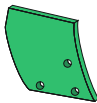

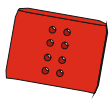
Parts to fit:

FORTSCHRITT 30Z and 30ZS ploughbodies

	<u>Bolt box no.</u>	<u>Article-no.</u>	<u>Designation</u>
Mouldboards, shines and accessories			
	BK016	301053847	Turbo-trashboard R
	BK015	301010104	Mouldboard extension R
	BK010	301010088	Shin R
	BK011	301010087	Mouldboard R
Shares, points and accessories			
	BK037	301000045WS	EUROSHARE R
	BK037	301000045	EUROSHARE R
	BK037	301000045A	Ploughshare R
	BK094	93105	Rev. Point R
	BK095	73091	Share knife R
Landsides			
	BK134	301010171	Landside, short R
		301010158	Landside, long R
	BK036	301010172	Landside, long R
Skim shares and skim mouldboards			
	BK010	301010086	Skim mouldboard R
	BK009	301000035	Skim share R
Parts to mount on landsides			
	BK094	63600A	Wearing plate, rev. R&L
	BK094	63601A	Wearing plate, rev. R&L
	BK052	1349408	Sword coulter R
	BK096	800MOL	Subsoiler blade R

Parts to fit:

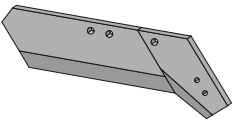
FRAUGDE CAX ploughbody

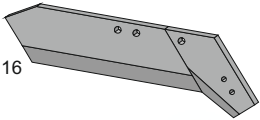
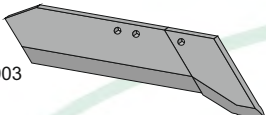
	<u>Bolt box no.</u>	<u>Article-no.</u>	<u>Designation</u>
Shares, points and accessories			
 93114	BK095	73091	Share knife R
	BK094	93105	EUROPOINT Rev. R
	BK095	9310MOLC	EUROCARBIDE M3 point R
 73091		93105	
		9310MOLC	
 93116	BK123	93114	Share f/rev. point 14" R
	BK123	93116	Share f/rev. point 16" R
 93003	BK123	93003	Ploughshare 16" R

Parts to fit:



FRAUGDE FK ploughbody

Shares, points and accessories			
 93047	BK123	93047	Ploughshare 14" R

Landside



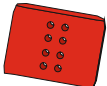



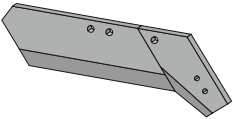

 93660	93660	Landside R
--	-------	------------

Parts to mount on landsides

 63600A	 63601A	 1349408	 800MOL	BK094 63600A BK094 63601A BK052 1349408 BK096 800MOL	Wearing plate, rev. R&L Wearing plate, rev. R&L Sword coulter R Subsoiler blade R
---	---	--	---	---	--

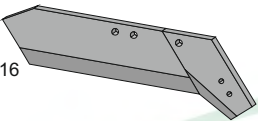
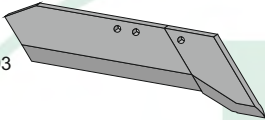
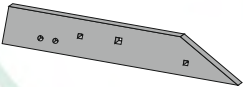
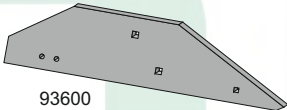
Parts to fit:

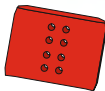
FRAUGDE FA ploughbody







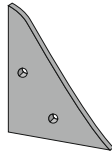

	<u>Bolt box no.</u>	<u>Article-no.</u>	<u>Designation</u>
Shares, points and accessories			
93114	BK095	73091	Share knife R
	BK094	93105	EUROPOINT Rev. R
	BK095	9310MOLC	EUROCARBIDE M3 point R
		73091	
			
93116	BK123	93114	Share f/rev. point 14" R
	BK123	93116	Share f/rev. point 16" R
	BK123	93003	Ploughshare 16" R
93003			
			
Landsides			
93650		93650	Landside, low R
		93600	Landside, tall R
			
Parts to mount on landsides			
63600A	BK094	63600A	Wearing plate, rev. R&L
	BK094	63601A	Wearing plate, rev. R&L
	BK052	1349408	Sword coulter R
	BK096	800MOL	Subsoiler blade R
			

Did you know...

that our sword coulter 1349408/1349409 will reduce the risk of damages from stones by more than 90% if you are using wide tires.

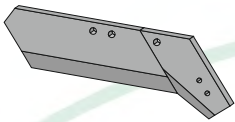
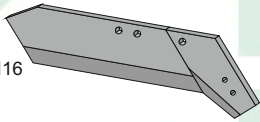
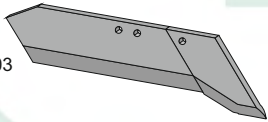
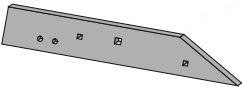
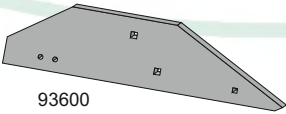
Parts to fit

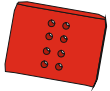
FRAUGDE FA and FKA ploughbodies

	<u>Bolt box no.</u>	<u>Article-no.</u>	<u>Designation</u>
Shin			
	BK119	93201	Shin R
Shares, points and accessories			
	BK095	73091	Share knife R
	BK094	93105	•EUROPOINT Rev. R
	BK095	9310MOLC	EUROCARBIDE M3 point R
	BK123	93114	Share f/rev. point 14" R
	BK123	93116	Share f/rev. point 16" R
	BK123	93003	Ploughshare 16" R
Landsides			
		93650	Landside, low R
		93600	Landside, tall R
Parts to mount on landsides			
	BK094	63600A	Wearing plate, rev. R&L
	BK094	63601A	Wearing plate, rev. R&L
	BK052	1349408	Sword coulter R
	BK096	800MOL	Subsoiler blade R

Parts to fit:

FRAUGDE FS and GS ploughbodies











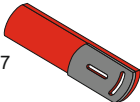
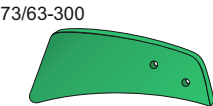
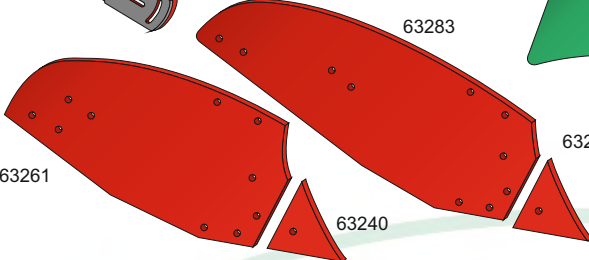
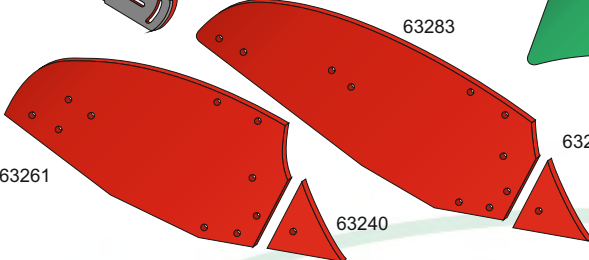

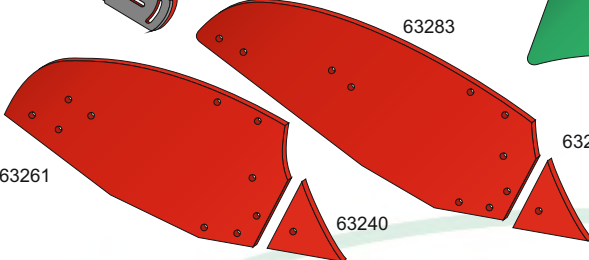
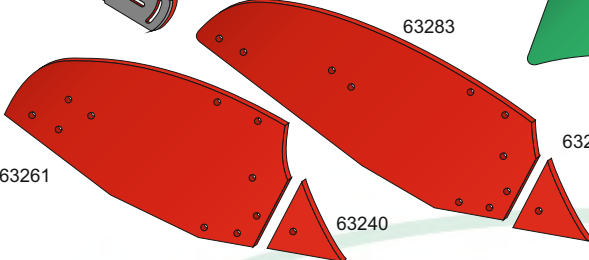
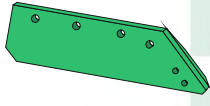
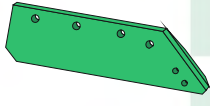

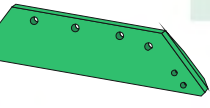
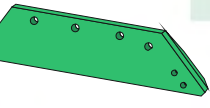

	<u>Bolt box no.</u>	<u>Article-no.</u>	<u>Designation</u>
Accessories			
73/63-300 	BK167	73/63-300	Turbo-trashboard R
73/63-310 		73/63-310	Fittings for trashboard R
Shares, points and accessories			
53087 	BK095	73091	Share knife R
	BK094	53090	EUROPOINT Rev. R
	BK095	5309MOLC	EUROCARBIDE M3 point R
		73091	
	BK100	53087	Share f/rev. 14" R
	BK100	53088	Share f/rev. 16" R
Landside			
53684 	BK118	53684	Landside, short R
Parts to mount on landsides			
	BK094	63600A	Wearing plate, rev. R&L
	BK094	63601A	Wearing plate, rev. R&L
	BK052	1349408	Sword coulter R
	BK096	800MOL	Subsoiler blade R

Did you know...

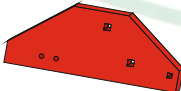
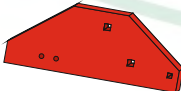
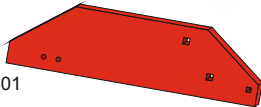
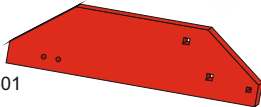
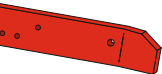
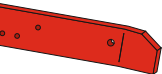
that if your plough is equipped with Mølbros shares and points it is always the point which enters the soil first.

Parts to fit

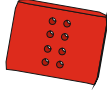









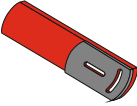

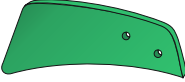

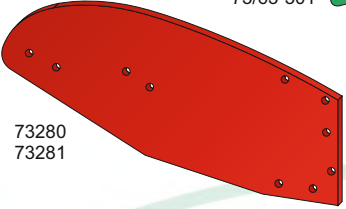
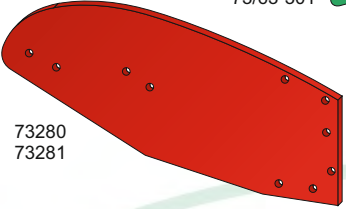



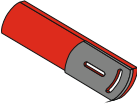

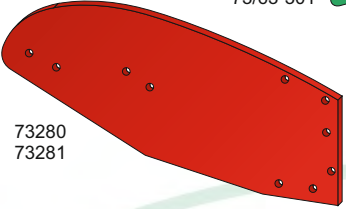
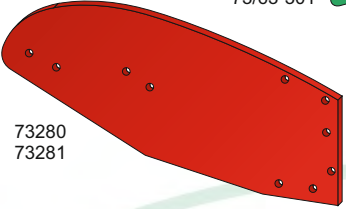
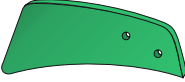
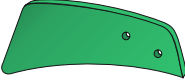



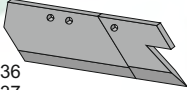

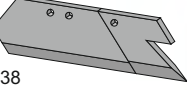

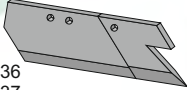

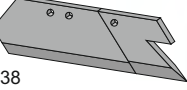
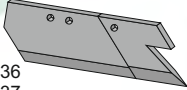

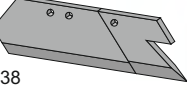
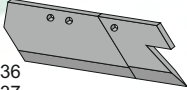

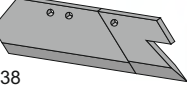
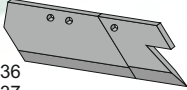

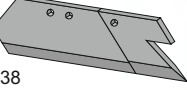
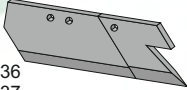

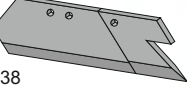
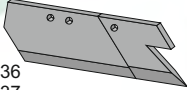

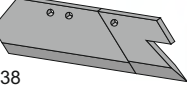
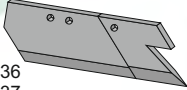

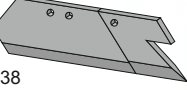
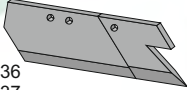

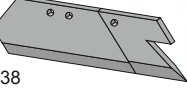
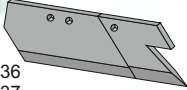

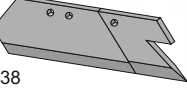
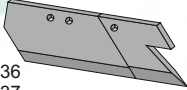

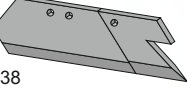
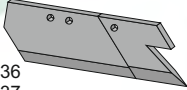

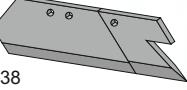
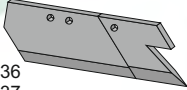

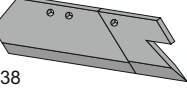
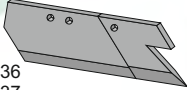

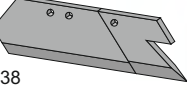
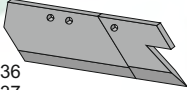

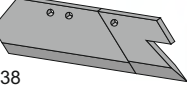
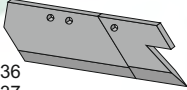

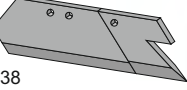
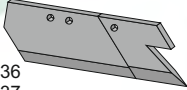

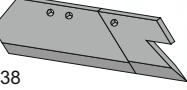
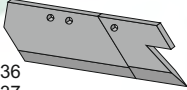

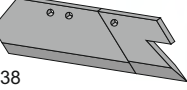
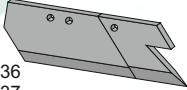

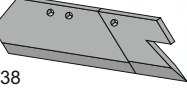
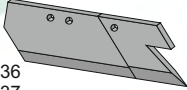

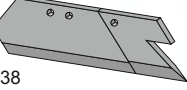
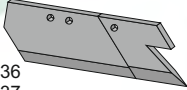

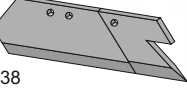
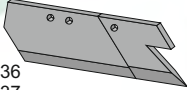

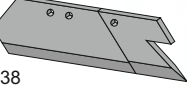
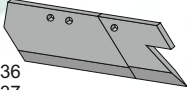

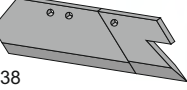
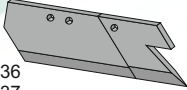

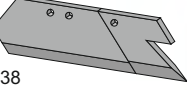
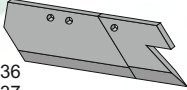

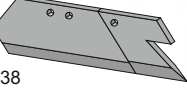
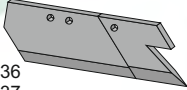

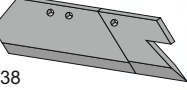
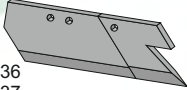

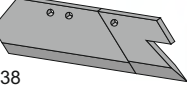
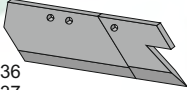

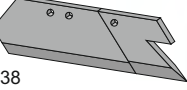
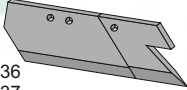

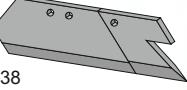
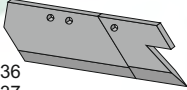

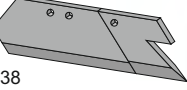
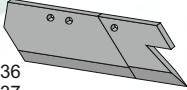

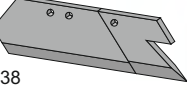
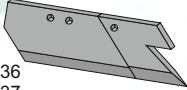

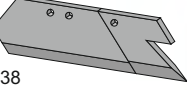
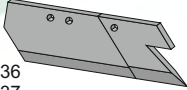

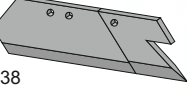
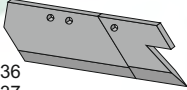

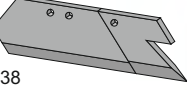
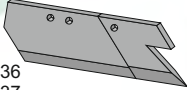

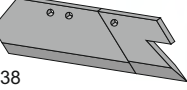
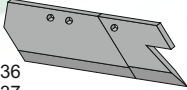

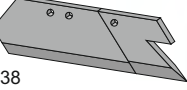
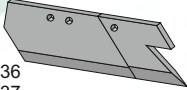

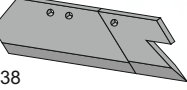
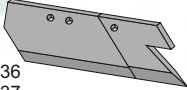

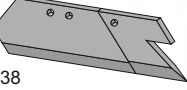
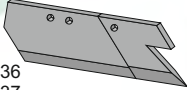

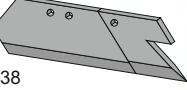
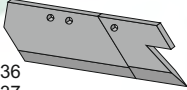
FRAUGDE MS ploughbody

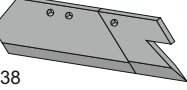
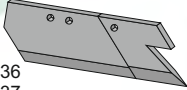
	Bolt box no.	Article-no.	Designation
Mouldboards, shins and accessories			
	BK167	73/63-300	Turbo-trashboard R
		73/63-310	Fittings for trashboard R
	BK056	63283	Mouldboard R
	BK056	63261	Mouldboard R
	BK082	53387	Mouldboard extension R
	BK053	63240	Shin R
		53387	Mouldboard extension R
		63240	Shin R
Shares, points and accessories			
	BK100	63014	EUROSHARE 14" R
	BK100	63015	EUROSHARE 16" R
	BK095	73091	Share knife R
	BK094	53090	EUROPOINT Rev. R
	BK095	5309MOLC	EUROCARBIDE M3 point R
		63014	EUROSHARE 14" R
		63015	EUROSHARE 16" R
		73091	Share knife R
		53090	EUROPOINT Rev. R
		5309MOLC	EUROCARBIDE M3 point R
Landsides			
	BK118	63602	Landside, short R
	BK118	63601	Landside, long R
	BK103	63605	Landside, short, low R
	BK103	63603	Landside, long, low R
		63602	Landside, short R
		63601	Landside, long R
		63605	Landside, short, low R
		63603	Landside, long, low R
Parts to mount on landsides			
	BK094	63600A	Wearing plate, rev. R&L
	BK094	63601A	Wearing plate, rev. R&L
	BK052	1349408	Sword coulter R
	BK096	800MOL	Subsoiler blade R

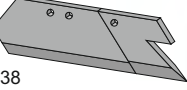
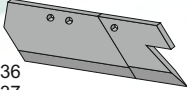

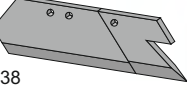
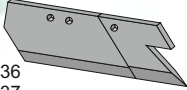

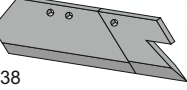
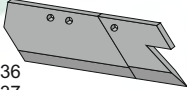
Parts to fit:

FRAUGDE 208 ploughbody

	<u>Bolt box no.</u>	<u>Article-no.</u>	<u>Designation</u>
Mouldboards, shins and accessories			
	BK167	73/63-300	Turbo-trashboard R
	BK167	73/63-301	Turbo-trashboard L
		73/63-310	Fittings for trashboard R
		73/63-311	Fittings for trashboard L
	BK082	53387	Mouldboard extension R
	BK082	63388	Mouldboard extension L
	BK056	73280	Mouldboard R
	BK056	73281	Mouldboard L
	BK052	73250	Shin R
	BK052	73251	Shin L
		53387	
		63388	
		73280	
		73281	
		73/63-300	
		73/63-301	
		73/63-310	
		73/63-311	
		73250	
		73251	
Shares and points			
		93131	Barpoint R&L
	BK099	93136	Share for barpoint 14" R
	BK099	93137	Share for barpoint 14" L
	BK099	93138	Share for barpoint 16" R
	BK099	93139	Share for barpoint 16" L
		93136	
		93137	
		93138	
		93139	
		93136	
		93137	
		93138	
		93139	
		93136	
		93137	
		93138	
		93139	
		93136	
		93137	
		93138	
		93139	
		93136	
		93137	
		93138	
		93139	
		93136	
		93137	
		93138	
		93139	
		93136	
		93137	
		93138	
		93139	
		93136	
		93137	
		93138	
		93139	
		93136	
		93137	
		93138	
		93139	
		93136	
		93137	
		93138	
		93139	
		93136	
		93137	
		93138	
		93139	
		93136	
		93137	
		93138	
		93139	
		93136	
		93137	
		93138	
		93139	
		93136	
		93137	
		93138	
		93139	
		93136	
		93137	
		93138	
		93139	
		93136	
		93137	
		93138	
		93139	
		93136	
		93137	
		93138	
		93139	
		93136	
		93137	
		93138	
		93139	
		93136	
		93137	
		93138	
		93139	
		93136	
		93137	
		93138	
		93139	
		93136	
		93137	
		93138	
		93139	
		93136	
		93137	
		93138	
		93139	
		93136	
		93137	
		93138	
		93139	
		93136	
		93137	
		93138	
		93139	
		93136	
		93137	
		93138	
		93139	
		93136	
		93137	
		93138	
		93139	
		93136	
		93137	
		93138	
		93139	
		93136	
		93137	
		93138	
		93139	
		93136	
		93137	
		93138	
		93139	
		93136	
		93137	
		93138	
		93139	
		93136	
		93137	
		93138	
		93139	
		93136	
		93137	
		93138	
		93139	
		93136	
		93137	
		93138	
		93139	
		93136	
		93137	
		93138	
		93139	
		93136	
		93137	
		93138	
		93139	
		93136	
		93137	
		93138	
		93139	
		93136	
		93137	
		93138	
		93139	
		93136	
		93137	
		93138	
		93139	
		93136	
		93137	
		93138	
		93139	
		93136	
		93137	
		93138	
		93139	
		93136	
		93137	
		93138	
		93139	
		93136	
		93137	
		93138	
		93139	
		93136	
		93137	

Parts to fit

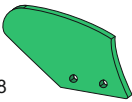
FRAUGDE ploughs

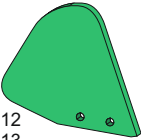
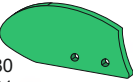
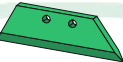
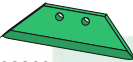
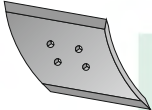
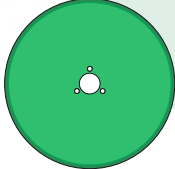
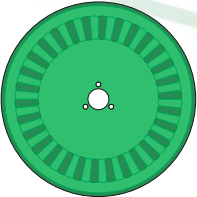
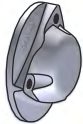
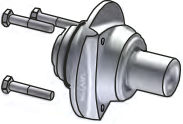
	Bolt box no.	Article-no.	Designation
Skim shares and skim mouldboards			
	BK026	66878	Skim mouldboard R
66878	BK004	56873	Skim share, short R
	BK004	66873V	Skim share, short L
56873 66873V	BK026	76812	Skim mouldboard R
	BK026	76813	Skim mouldboard L
76812 76813	BK026	66880	Skim mouldboard R
	BK026	66881	Skim mouldboard L
66880 66881	BK004	66868	Skim share, long R
	BK004	66869	Skim share, long L
66868 66869	BK004	66868/ 66869	Skim share, R&L
		96550	Skim share, rev. R
96550			
			
66868/66869			
Disc coulters and accessories			
		56112	Disc coulters 18" R&L
56112		56114	Disc coulters, rippled 20" R&L
		56115	Disc coulters, notched 18" R&L
56114		56156	Universal cover for hub R&L
		60624	Hub for disc coulters Ø30 mm R&L
56156			
			
60624			











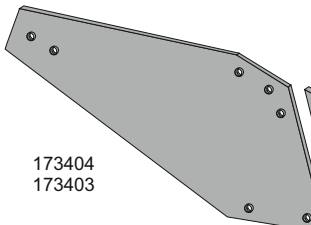
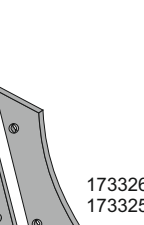
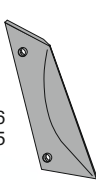
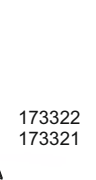
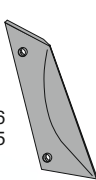
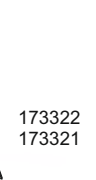
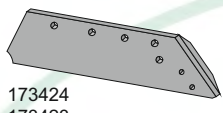
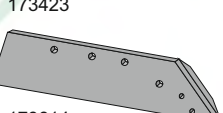
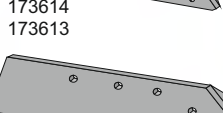
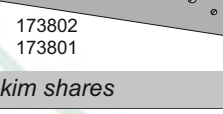
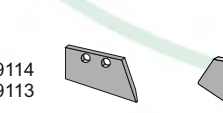

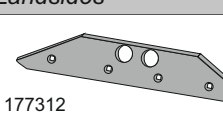
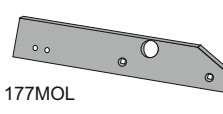
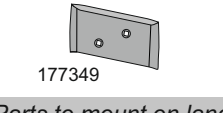
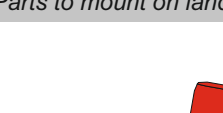
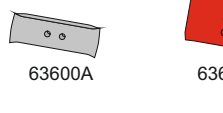



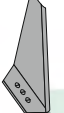

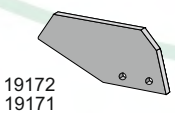

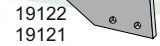
Parts to fit:

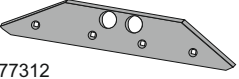
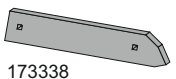
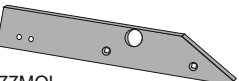
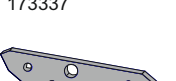
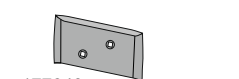
GOIZIN ploughs

		<u>Bolt box no.</u>	<u>Article-no.</u>	<u>Designation</u>
Shares				
010406			010406	EUROSHARE 14" R
010454			010456	EUROSHARE 14" L
			010506	EUROSHARE 15" R
010506			010556	EUROSHARE 15" L
010606			010606	EUROSHARE 16" R
010656			010656	EUROSHARE 16" L
			010004	EUROPOINT Rev. R
			010054	EUROPOINT Rev. L
			010104	EUROPOINT Rev. R
			010154	EUROPOINT Rev. L
010444			010444	EUROSHARE 14" R
010494			010494	EUROSHARE 14" L
010544			010544	EUROSHARE 15" R
010594			010594	EUROSHARE 15" L
010644			010644	EUROSHARE 16" R
010694			010694	EUROSHARE 16" L
Skim shares				
010732			010732	Skim share R
010782			010782	Skim share L
Landsides				
010334			010334	Landside R
010384			010384	Landside L
010534			010534	Landside R
010584			010584	Landside L
01053MOL			01053MOL	Landside R
01058MOL			01058MOL	Landside L
Parts to mount on landsides				
63600A	63601A	1349408	1349409	800MOL
				801MOL
				BK094
				63600A
				BK094
				63601A
				BK052
				1349408
				BK052
				1349409
				BK096
				800MOL
				BK096
				801MOL
				BK096
				801MOL
				801MOL
				Wearing plate, rev. R&L
				Wearing plate, rev. R&L
				Sword coulter R
				Sword coulter L
				Subsoiler blade R
				Subsoiler blade L











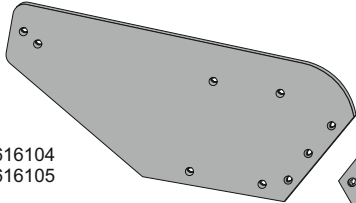





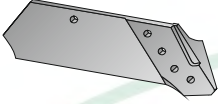

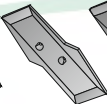
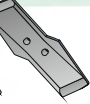

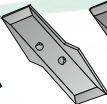
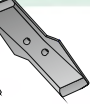
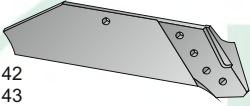
Parts to fit:

GREGOIRE-BESSON ploughs

	<u>Bolt box no.</u>	<u>Article-no.</u>	<u>Designation</u>
Mouldboard and shin			
		173404	Mouldboard R
		173403	Mouldboard L
	BK052	173326	Shin R
	BK052	173325	Shin L
	BK052	173322	Shin R
	BK052	173321	Shin L
Shares, points and accessories			
	BK114	173424	EUROSHARE 14" R
	BK114	173423	EUROSHARE 14" L
	BK113	173614	EUROSHARE 16" R
	BK113	173613	EUROSHARE 16" L
	BK113	173802	EUROSHARE 18" R
	BK113	173801	EUROSHARE 18" L
	BK095	173332	EUROPOINT Rev. R
	BK095	173331	EUROPOINT Rev. L
	BK096	173MOL R	Share knife R (173324)
	BK096	173MOL L	Share knife L (173323)
	BK095	MOL332C	EUROCARBIDE M3 point R
	BK095	MOL331C	EUROCARBIDE M3 point L
		173332	
		173331	
		173MOLR	
		173MOLL	
Skim shares			
	BK052	19114	Skim shares R
	BK052	19113	Skim shares
	BK052	19172	Skim mouldboard R
	BK052	19171	Skim mouldboard L
		19122	Skim mouldboard R
		19121	Skim mouldboard L
Landsides			
	BK036	177312	Landside R&L
	BK036	177MOL	Landside R&L
	BK036	173338	Landside, short R
	BK036	173337	Landside, short L
	BK036	173388	Landside, rev. R&L
		177349	Wearing plate, rev. R&L
Parts to mount on landsides			
	BK094	63600A	Wearing plate, rev. R&L
	BK094	63601A	Wearing plate, rev. R&L
	BK052	1349408	Sword coultter R
	BK052	1349409	Sword coultter L
	BK096	800MOL	Subsoiler blade R
	BK096	801MOL	Subsoiler blade L
		1349409	

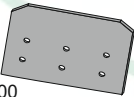
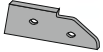
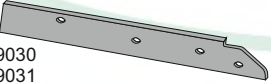
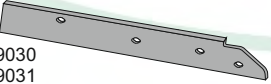





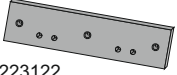
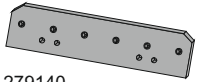

Parts to fit

KUHN RH/RLM ploughbodies

	Bolt box no.	Article-no.	Designation
Shin			
		616104	Mouldboard R
		616105	Mouldboard L
	BK069	619038	Shin R
	BK069	619039	Shin L
		619038	
		619039	
Shares, points and accessories			
	BK095	622180	EUROPOINT rev. R
	BK095	622181	EUROPOINT rev. L
	BK095	MOL180C	EUROCARBIDE M3 point R
	BK095	MOL181C	EUROCARBIDE M3 point L
	BK095	622128	EUROPOINT Z- R
	BK095	622129	EUROPOINT Z- L
	BK095	622174	EUROPOINT Z- reinforc. R
	BK095	622175	EUROPOINT Z- reinforc. L
	BK112	622140	Share f/rev. point 14" R
	BK112	622141	Share f/rev. point 14" L
	BK112	622142	Share f/rev. point 16" R
	BK112	622143	Share f/rev. point 16" L
	BK095	270MOL	Share knife R
	BK095	271MOL	Share knife L
Landsides			
	BK069	279028	Landside, short R
	BK069	279029	Landside, short L
	BK057	279030	Landside, long R
	BK057	279021	Landside, long L
		226100	Steering plate R&L
		279030	
		279031	

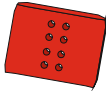
Parts to fit:

KUHN PP and C ploughbodies

Landsides			
	BK099	223122	Landside, rev. R&L
	BK099	279140	Landside, rev. R&L
	BK098	279138	Skim point R
	BK098	279139	Skim point L
Parts to mount on landsides			
	BK094	63600A	Wearing plate, rev. R&L
	BK094	63601A	Wearing plate, rev. R&L
	BK052	1349408	Sword coulter R
	BK052	1349409	Sword coulter L
	BK096	800MOL	Subsoiler blade R
	BK096	801MOL	Subsoiler blade L

Parts to fit:

KUHN H4 and H6 ploughbodies

		<u>Bolt box no.</u>	<u>Article-no.</u>	<u>Designation</u>
Mouldboards, shins and accessories				
648102 648103		Bk069	619122	Turbo-trashboard R
		BK069	619123	Turbo-trashboard L
612108 612109		BK071	612108	Mouldboard R H4
		BK071	612109	Mouldboard L H4
		BK077	619120	Shin R H4
		BK077	619121	Shin L H4
		BK071	612110	Mouldboard R H6
		BK071	612111	Mouldboard L H6
		BK077	619128	Shin R H6
		BK077	619129	Shin L H6
		BK084	648102	Mouldboard extension R
		BK084	648103	Mouldboard extension L
Shares, points and accessories				
622200 (622166) 622201 (622167)		BK113	622200	EUROSHARE 14" H
		BK113	622201	EUROSHARE 14" V
		BK113	622202	EUROSHARE 16" H
		BK113	622203	EUROSHARE 16" V
		BK113	622204	EUROSHARE 18" R
		BK113	622205	EUROSHARE 18" L
		BK095	622128	EUROPOINT Z- R
		BK095	622129	EUROPOINT Z- L
		BK095	622174	EUROPOINT Z-reinforc. R
		BK095	622175	EUROPOINT Z-reinforc. L
		BK095	622180	EUROPOINT rev. R
		BK095	622181	EUROPOINT rev. L
		BK095	MOL180C	EUROCARBIDE M3 point R
		BK095	MOL181C	EUROCARBIDE M3 point L
		BK165	MOL202C	EUROCARBIDESHARE M516" R
		BK165	MOL203C	EUROCARBIDESHARE M516" L
		BK165	MOL202	EUROSHARE M5 16" R
		BK165	MOL203	EUROSHARE M5 16" L
		BK166	MOL25-0	M7-Adapter R
		BK166	MOL25-1	M7-Adapter L
		BK166	MOL83	M7 point rev. R/L
			4979058	Wegde for M7 point
		BK096	270MOL	Share knife R
		BK096	271MOL	Share knife L
For KUHN-HUARD Euroshares, please use landsidepoint 223120/223121 and 223120MOL/223121MOL.				
Landsides				
223122		BK097	223120	Skim point R
		BK097	223121	Skim point L
		BK097	223120MOL	Skim point R
		BK097	223121MOL	Skim point L
		BK099	223122	Landside, rev. R&L
		BK099	279140	Landside, rev. R&L
Parts to mount on landsides				
63600A		BK094	63600A	Wearing plate, rev. R&L
		BK094	63601A	Wearing plate, rev. R&L
		BK052	1349408	Sword coulter R
		BK052	1349409	Sword coulter L
		BK096	800MOL	Subsoiler blade R
		BK096	801MOL	Subsoiler blade L

Parts to fit:

KUHN HB4 and HB6 ploughbodies

	<u>Bolt box no.</u>	<u>Article-no.</u>	<u>Designation</u>
Shins and accessories			
	BK069	619122	Turbo-trashboard R
	BK069	619123	Turbo-trashboard L
	BK077	619120	Mouldboard R H6
	BK077	619121	Mouldboard L H6
	BK077	619128	Shin R H6
	BK077	619129	Shin L H6
	BK084	648102	Mouldboard extension R
	BK084	648103	Mouldboard extension L
Shares, points and accessories			
	BK113	622200	EUROSHARE 14" H
	BK113	622201	EUROSHARE 14" V
	BK113	622202	EUROSHARE 16" H
	BK113	622203	EUROSHARE 16" V
	BK113	622204	EUROSHARE 18" R
	BK113	622205	EUROSHARE 18" L
	BK095	622128	EUROPOINT Z- R
	BK095	622129	EUROPOINT Z- L
	BK095	622174	EUROPOINT Z-reinforc. R
	BK095	622175	EUROPOINT Z-reinforc. L
	BK095	622180	EUROPOINT rev. R
	BK095	622181	EUROPOINT rev. L
	BK095	MOL180C	EUROCARBIDE M3 point R
	BK095	MOL181C	EUROCARBIDE M3 pointL
	BK165	MOL202C	EUROCARBIDESHARE M516" R
	BK165	MOL203C	EUROCARBIDESHARE M516" L
	BK165	MOL202	EUROSHARE M5 16" R
	BK165	MOL203	EUROSHARE M5 16" L
	BK166	MOL25-0	M7-Adapter R
	BK166	MOL25-1	M7-Adapter L
	BK166	MOL83	M7 point rev. R/L
		4879058	Wedge for M7 point
	BK096	270MOL	Share knife R
	BK096	271MOL	Share knife L
For KUHN-HUARD Euroshares, please use landsidepoint 223120/223121 and 223120MOL/223121MOL.			
Landsides			
	BK097	223120	Skim point R
	BK097	223121	Skim point L
	BK097	223120MOL	Skim point R
	BK097	223121MOL	Skim point L
	BK099	223122	Landside, rev. R&L
	BK099	279140	Landside, rev. R&L
Parts to mount on landsides			
	BK094	63600A	Wearing plate, rev. R&L
	BK094	63601A	Wearing plate, rev. R&L
	BK052	1349408	Sword coulter R
	BK052	1349409	Sword coulter L
	BK096	800MOL	Subsoiler blade R
	BK096	801MOL	Subsoiler blade L

Parts to fit:

KUHN SK ploughbody

	<u>Bolt box no.</u>	<u>Article-no.</u>	<u>Designation</u>	
Mouldboard and shin				
<p>616242 616243</p> <p>619278 619279</p>	BK071	616242	Mouldboard R	
	BK071	616243	Mouldboard L	
	BK150	619278	Shin R	
	BK150	619279	Shin L	
	Shares, points and accessories			
	<p>622328 622329</p> <p>622180 622181</p> <p>622128 622129</p> <p>622174 622175</p> <p>MOL180C MOL181C</p> <p>622330 (H0401860) 622331 (H0401870)</p> <p>MOL203C MOL202C</p> <p>MOL300C MOL301C</p> <p>MOL202 MOL203</p> <p>MOL30-0 MOL30-1</p> <p>MOL83</p> <p>4879058</p> <p>270MOL 271MOL</p>	BK095	622180	EUROPOINT rev. R
BK095		622181	EUROPOINT rev. L	
BK095		MOL180C	EUROCARBIDE M3 point R	
BK095		MOL181C	EUROCARBIDE M3 point L	
BK095		622128	EUROPOINT Z- R	
BK095		622129	EUROPOINT Z- L	
BK095		622174	EUROPOINT Z- reforc. R	
BK095		622175	EUROPOINT Z- reforc. L	
BK113		622328	Share f/rev. point 14" R	
BK113		622329	Share f/rev. point 14" L	
BK113		622330	Share f/rev. point 16" R	
BK113		622331	Share f/rev. point 16" L	
BK165		MOL202C	EUROCARBIDESHARE M516" R	
BK165		MOL203C	EUROCARBIDESHARE M516" L	
BK165		MOL202	EUROSHARE M5 16" R	
BK165		MOL203	EUROSHARE M5 16" L	
BK166		MOL30-0	M7-Adapter R	
BK166		MOL30-1	M7-Adapter L	
BK166		MOL83	M7 point rev. R/L	
BK166		4879058	Wegde for M7 point	
BK166	MOL300C	EUROCARBIDE M5 point R		
BK166	MOL301C	EUROCARBIDE M5 point L		
BK096	270MOL	Share knife R		
BK096	271MOL	Share knife L		
For KUHN-HUARD Euroshares, please use landsidepoint MOL761216 / MOL761217.				
Landsides				
<p>279140</p> <p>MOL761216 MOL761217</p> <p>223122</p>	BK099	279140	Landside, rev. R&L	
	BK097	MOL761216	Skim point R	
	BK097	MOL761217	Skim point L	
	BK099	223122	Landside, rev. R&L	
Parts to mount on landsides				
<p>63600A</p> <p>63601A</p> <p>1349408 1349409</p> <p>800MOL 801MOL</p>	BK094	63600A	Wearing plate, rev. R&L	
	BK094	63601A	Wearing plate, rev. R&L	
	BK052	1349408	Sword coulter R	
	BK052	1349409	Sword coulter L	
	BK096	800MOL	Subsoiler blade R	
	BK096	801MOL	Subsoiler blade L	

Parts to fit:

KUHN VL ploughbody

Shin

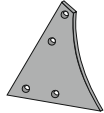

H0403520
H0403530

Bolt box no.	Article-no.	Designation
BK150	H0403520	Shin R
BK150	H0403530	Shin L

Shares, points and accessories

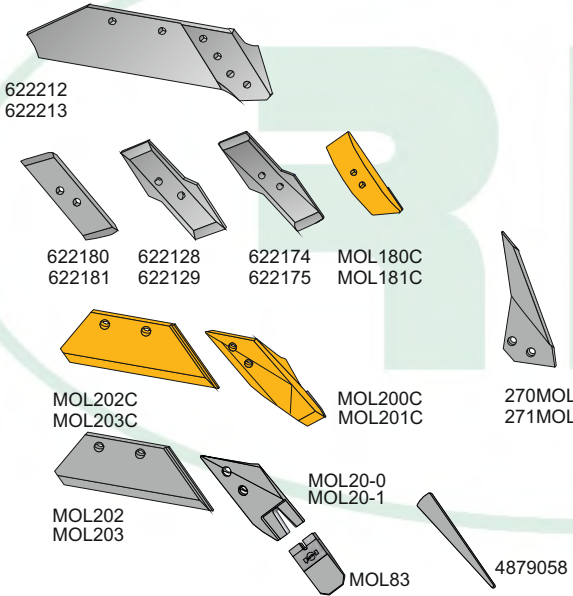

BK095	622180	EUROPOINT rev. R
BK095	622181	EUROPOINT rev. L
BK095	MOL180C	EUROCARBIDE M3 point R
BK095	MOL181C	EUROCARBIDE M3 point L
BK095	622128	EUROPOINT Z- R
BK095	622129	EUROPOINT Z- L
BK095	622174	EUROPOINT Z- reforc. R
BK095	622175	EUROPOINT Z- reforc. L
BK166	MOL200C	EUROCARBIDE M5 point R
BK166	MOL201C	EUROCARBIDE M5 point L
BK113	622213	Share f/rev. point 16" R
BK113	622212	Share f/rev. point 16" L
BK165	MOL202C	EUROCARBIDESHARE M5 16" R
BK165	MOL203C	EUROCARBIDESHARE M5 16" L
BK165	MOL202	EUROSHARE M5 16" R
BK165	MOL203	EUROSHARE M5 16" L
BK166	MOL20-0	M7-Adpter R
BK166	MOL20-1	M7-Adpter L
BK166	MOL83	M7 point rev. R/L
BK096	4879058	Wedge for M7 point
BK096	270MOL	Share knife R
BK096	271MOL	Share knife L

Landsides

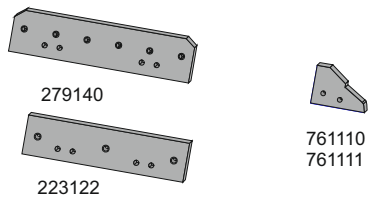

BK099	279140	Landside, rev. R&L
BK099	223122	Landside, rev. R&L
BK098	761110	Skim point R
BK098	761111	Skim point L

Parts to mount on landsides

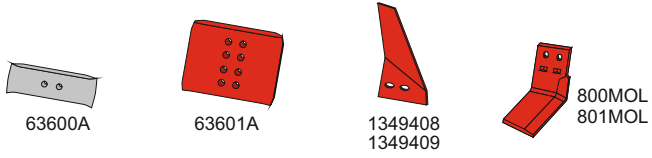

BK094	63600A	Wearing plate, rev. R&L
BK094	63601A	Wearing plate, rev. R&L
BK052	1349408	Sword coultter R
BK052	1349409	Sword coultter L
BK096	800MOL	Subsoiler blade R
BK096	801MOL	Subsoiler blade L

Parts to fit:

KUHN VS/N ploughbodies

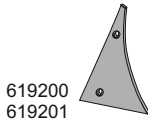
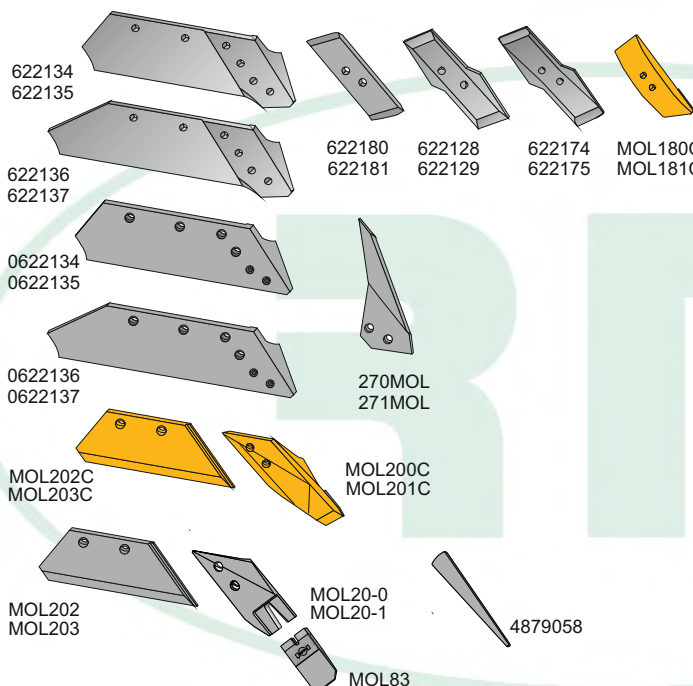
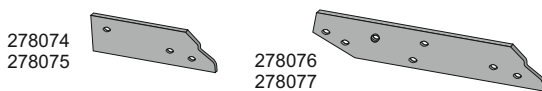
	Bolt box no.	Article-no.	Designation
Shin			
 <p>619200 619201</p>	BK052	619200	Shin R
	BK052	619201	Shin L
Shares, points and accessories			
 <p>622134 622135</p> <p>622136 622137</p> <p>0622134 0622135</p> <p>0622136 0622137</p> <p>MOL202C MOL203C</p> <p>MOL202 MOL203</p> <p>622180 622181</p> <p>622128 622129</p> <p>622174 622175</p> <p>MOL180C MOL181C</p> <p>270MOL 271MOL</p> <p>MOL200C MOL201C</p> <p>MOL20-0 MOL20-1</p> <p>MOL83</p> <p>4879058</p>	BK095	622180	EUROPOINT rev. R
	BK095	622181	EUROPOINT rev. L
	BK095	MOL180C	EUROCARBIDE M3 point R
	BK095	MOL181C	EUROCARBIDE M3 point L
	BK095	622128	EUROPOINT Z- R
	BK095	622129	EUROPOINT Z- L
	BK095	622174	EUROPOINT Z- reforc. R
	BK095	622175	EUROPOINT Z- reforc. L
	BK166	MOL200C	EUROCARBIDE M5 point R
	BK166	MOL201C	EUROCARBIDE M5 point L
	BK113	622134	Share f/rev. point 14" R
	BK113	622135	Share f/rev. point 14" L
	BK113	622136	Share f/rev. point 16" R
	BK113	622137	Share f/rev. point 16" L
	BK113	0622134	Share f/rev. point 14" R
	BK113	0622135	Share f/rev. point 14" L
	BK113	0622136	Share f/rev. point 16" R
	BK113	0622137	Share f/rev. point 16" L
	BK165	MOL202C	EUROCARBIDESHARE M5 16" R
	BK165	MOL203C	EUROCARBIDESHARE M5 16" L
	BK165	MOL202	EUROSHARE M5 16" R
	BK165	MOL203	EUROSHARE M5 16" L
	BK166	MOL20-0	M7-Adpter R
BK166	MOL20-1	M7-Adpter R	
BK166	MOL83	M7 point rev. R/L	
BK096	4879058	Wegde for M7 point	
BK096	270MOL	Share knife R	
BK096	271MOL	Share knife L	
Landside			
 <p>278074 278075</p> <p>278076 278077</p>	BK077	278074	Landside, short R
	BK077	278075	Landside, short L
	BK072	278076	Landside, long R
	BK072	278077	Landside, long L

Parts to fit:

KUHN ploughs

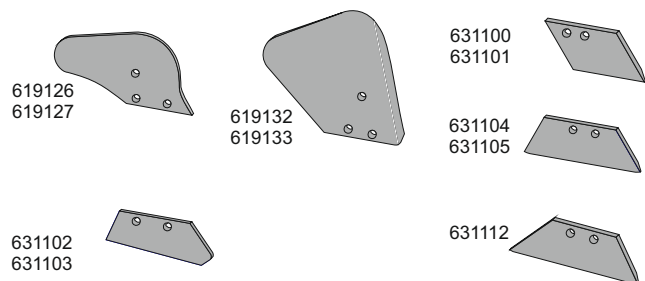
	Bolt box no.	Article-no.	Designation
Skim shares and skim mouldboards			
 <p>619126 619127</p> <p>619132 619133</p> <p>631102 631103</p> <p>631100 631101</p> <p>631104 631105</p> <p>631112</p>	BK058	619126	Skim mouldboard R
	BK058	619127	Skim mouldboard L
	BK058	619132	Skim mouldboard R
	BK058	619133	Skim mouldboard L
	BK052	631100	Skim share R
	BK052	631101	Skim share L
	BK052	631102	Skim share R
	BK052	631103	Skim share L
	BK052	631104	Skim share R
	BK052	631105	Skim share L
	BK052	631112	Skim share R&L

Parts to fit:

KVERNELAND ploughbody no. 3

		<u>Bolt box no.</u>	<u>Article-no.</u>	<u>Designation</u>
Mouldboards, shins and accessories				
<p>53387 63388</p>	<p>73/63-300 73/63-301</p>	BK167	73/63-300	Turbo-trashboard R
		BK167	73/63-301	Turbo-trashboard L
			73/63-310	Fittings for trashboard R
			73/63-311	Fittings for trashboard L
	<p>73/63-310 73/63-311</p>	BK082	53387	Mouldboard extension R
		BK082	63388	Mouldboard extension L
		BK056	63283	Mouldboard R
		BK056	63293	Mouldboard L
		BK056	63261	Mouldboard R
		BK056	63271	Mouldboard L
<p>63261 63271</p>	<p>63283 63293</p>	BK053	63240	Shin R
		BK053	63250	Shin L
Shares, points and accessories				
<p>063014 063017</p>	<p>53090 63090</p>	BK100	063014	EUROSHARE 14" R
		BK100	063017	EUROSHARE 14" L
	<p>5309MOLC 6309MOLC</p>	BK100	063015	EUROSHARE 16" R
		BK100	063018	EUROSHARE 16" L
<p>063015 063018</p>	<p>73091 73092</p>	BK096	73091	Share knife R
		BK096	73092	Share knife L
		BK094	53090	EUROPOINT Rev. R
		BK094	63090	EUROPOINT Rev. L
		BK095	5309MOLC	EUROCARBIDE M3 point R
		BK095	6309MOLC	EUROCARBIDE M3 point L
Landsides				
<p>63610 63602</p>		BK128	63610	Landside, short R&L
		BK103	63615	Landside, short, low R
		BK103	63606	Landside, short, low L
		BK103	63613	Landside, long, low R
		BK103	63604	Landside, long, low L
<p>63601</p>		BK118	63602	Landside, short R
		BK118	63601	Landside, long R
<p>63615 63606</p>	<p>63605</p>	BK103	63605	Landside, short, low R
		BK103	63603	Landside, long, low R
<p>63613 63604</p>	<p>63603</p>	BK136	63607	Conversion plate R
			63608	Conversion plate f/rev.plough R
			63609	Conversion plate f/rev.plough L
Parts to mount on landsides				
<p>63600A</p>	<p>63601A</p>	BK094	63600A	Wearing plate, rev. R&L
		BK094	63601A	Wearing plate, rev. R&L
<p>1349408 1349409</p>		BK052	1349408	Sword coulter R
		BK052	1349409	Sword coulter L
	<p>800MOL</p>	BK096	800MOL	Subsoiler blade R
		BK096	801MOL	Subsoiler blade L

Parts to fit:

KVERNELAND ploughbodies no. 6, 7, 8, 9 and 28

Mouldboards, shins and accessories		Bolt box no.	Article-no.	Designation
	73/63-300 73/63-301	BK167	73/63-300	Turbo-trashboard R
		BK167	73/63-301	Turbo-trashboard L
			73/63-310	Fittings for trashboard R
			73/63-311	Fittings for trashboard L
		BK156	073801	Brace R&L (for frog 73406/7)
		BK156	73803	Brace R&L (for frog 73411/12)
		BK156	073831	Brace R&L (for frog 73406/7)
		BK156	083810	Brace R&L (for frog 73406/7)
		BK113	73800	Brace fitting R
		BK113	73801	Brace fitting L
		BK082	53387	Mouldboard extension R
		BK082	63388	Mouldboard extension L
		BK059	73290	Mouldboard R
		BK059	73291	Mouldboard L
		BK056	73286	Mouldboard R
		BK056	73287	Mouldboard L
		BK056	73280	Mouldboard R
		BK056	73281	Mouldboard L
		BK154	83228	Mouldboard R
		BK154	83229	Mouldboard L
		BK058	73256	Shin R
		BK058	73257	Shin L
		BK052	73250	Shin R
		BK052	73251	Shin L
			73266	Bracket for shin R
			73267	Bracket for shin L
			73411	Frog R
			73412	Frog L
		73406	Frog R	
		73407	Frog L	
Shares, points and accessories		Bolt box no.	Article-no.	Designation
	073002 073003	BK113	073002	EUROSHARE 14" R
		BK113	073003	EUROSHARE 14" L
		BK113	073004	EUROSHARE 16" R
		BK113	073005	EUROSHARE 16" L
		BK114	073006	EUROSHARE 18" R
		BK114	073007	EUROSHARE 18" L
		BK114	073008	EUROSHARE 20" R
		BK114	073009	EUROSHARE 20" L
		BK170	83018	EUROSHARE M5 16" R
		BK170	83019	EUROSHARE M5 16" L
		BK170	83020	EUROSHARE M5 18" R
		BK170	83021	EUROSHARE M5 18" L
		BK170	83022	EUROSHARE M5 20" R
		BK170	83023	EUROSHARE M5 20" L
		BK111	83010C	EUROCARBIDE M5 point R
		BK111	83011C	EUROCARBIDE M5 point L
		BK111	MOL83-0	M7-adapter R
		BK111	MOL83-1	M7-adapter L
			MOL83	M7 point rev. R/L
			4879058	Wegde for M7 point
		BK095	73091	Share knife R
		BK095	73092	Share knife L
		BK094	53090	EUROPOINT Rev. R
		BK094	63090	EUROPOINT Rev. L
		BK095	5309MOLC	EUROCARBIDE M3 point R
		BK095	6309MOLC	EUROCARBIDE M3 point L
			73414	Bracket for 18" and 20" shares R
			73415	Bracket for 18" and 20" shares L
	BK170	MOL83018C	EUROCARBIDESHARE M5 16" R	
	BK170	MOL83019C	EUROCARBIDESHARE M5 16" L	

Did you know...





that you can wear out more than

six points before you have to replace the M7-adapter.

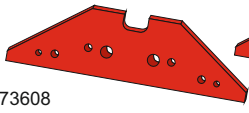
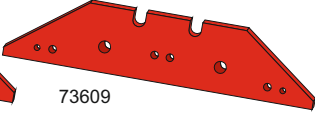
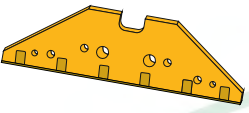
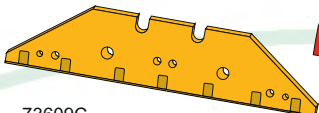
Parts to fit:

KVERNELAND ploughbodies no. 6, 7, 8, 9 and 28

Landsides and share knives		Bolt box no.	Article-no.	Designation
				
73608	73609			
			73088	
			73089	
		BK111	73608	Landside, short R&L
		BK111	73609	Landside, long R&L
		BK110	73088	Share knife R
		BK110	73089	Share knife L
		BK110	84320	Share knife R
		BK110	84321	Share knife L
				
73608C	73609C			
			84320	
			84321	
		BK111	73608C	Landside, coated short R&L
		BK111	73609C	Landside, coated long R&L

Parts to mount on landsides				
				
63600A	63601A	1349408	800MOL	
		1349409	801MOL	
				BK094 63600A
				BK094 63601A
				BK052 1349408
				BK052 1349409
				BK096 800MOL
				BK096 801MOL
				Wearing plate, rev. R&L
				Wearing plate, rev. R&L
				Sword coulter R
				Sword coulter L
				Subsoiler blade R
				Subsoiler blade L

Did you know...
 that Mølbros landsides are longer than original landsides.
 This feature gives your plough much more stability while
 ploughing which makes it easier to control the plough.

Did you know...
 that the upset forged front of the share gives an extra
 support for the reversible point or EUROPOINT and is
 designed to ensure that it is easy to get the plough into the
 soil.

Parts to fit:

KVERNELAND ploughbodies no. 12 and 19







		<u>Bolt box no.</u>	<u>Article-no.</u>	<u>Designation</u>
Mouldboards, shins and accessories				
	BK167	73/63-300	Turbo-trashboard R	
	BK167	73/63-301	Turbo-trashboard L	
		73/63-310	Fittings for trashboard R	
		73/63-311	Fittings for trashboard L	
	BK082	53387	Mouldboard extension R	
	BK082	63388	Mouldboard extension L	
	BK059	73290	Mouldboard R	
	BK059	73291	Mouldboard L	
	BK113	73800	Brace fitting R	
	BK113	73801	Brace fitting L	
	BK156	73805	Brace R&L (for frog 73406/7)	
	BK058	73230	Shin R	
	BK058	73231	Shin L	
	BK058	73241	Shin R	
	BK058	73242	Shin L	
	73266	Bracket for shin R		
	73267	Bracket for shin L		
	73435	Frog R		
	73436	Frog L		

		<u>Bolt box no.</u>	<u>Article-no.</u>	<u>Designation</u>
Shares, points and accessories				
	BK113	073054	EUROSHARE 14" R	
	BK113	073055	EUROSHARE 14" L	
	BK113	073056	EUROSHARE 16" R	
	BK113	073057	EUROSHARE 16" L	
	BK113	073080	EUROSHARE 18" R	
	BK113	073081	EUROSHARE 18" L	
	BK113	073084	EUROSHARE 20" R	
	BK113	073085	EUROSHARE 20" L	
	BK096	73091	Share knife R	
	BK096	73092	Share knife L	
	BK094	53090	EUROPOINT Rev. R	
	BK094	63090	EUROPOINT Rev. L	
	BK095	5309MOLC	EUROCARBIDE M3 point R	
	BK095	6309MOLC	EUROCARBIDE M3 point L	
	BK170	83018	EUROSHARE M5 16" R	
BK170	83019	EUROSHARE M5 16" L		
BK170	83020	EUROSHARE M5 18" R		
BK170	83021	EUROSHARE M5 18" L		
BK170	83022	EUROSHARE M5 20" R		
BK170	83023	EUROSHARE M5 20" L		
BK111	83012C	EUROCARBIDE M5 point R		
BK111	83013C	EUROCARBIDE M5 point L		
BK111	MOL83-2	M7-adaptor R		
BK111	MOL83-3	M7-adaptor L		
	MOL83	M7 point rev. R/L		
	4879058	Wegde for M7 point		
BK170	MOL83018C	EUROCARBIDESHARE M5 16" R		
BK170	MOL83019C	EUROCARBIDESHARE M5 16" L		

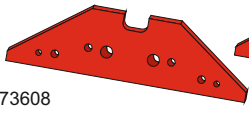
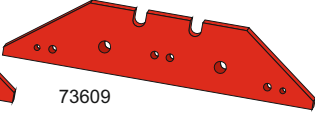
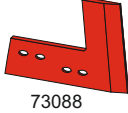
Did you know...
 that the special hole shape of the point for EUROSHARE makes it possible to mount it with a unique high headed bolt which allow the point to be worn even thinner?

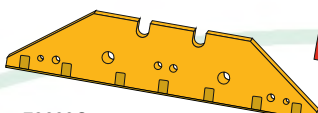

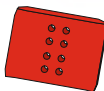







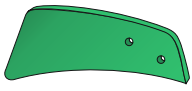

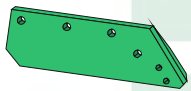
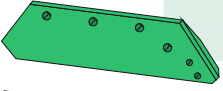
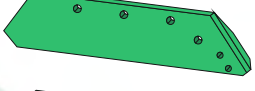
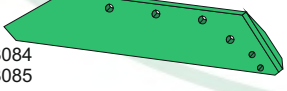
Parts to fit:

KVERNELAND ploughbodies no. 12 and 19

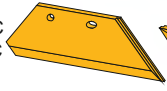
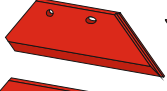
		<u>Bolt box no.</u>	<u>Article-no.</u>	<u>Designation</u>
Landsides and share knives				
				
73608	73609			
				
			73088 73089	
		BK111	73608	Landside, short R&L
		BK111	73609	Landside, long R&L
		BK110	73088	Share knife R
		BK110	73089	Share knife L
		BK110	84320	Share knife R
		BK110	84321	Share knife L
				
73608C	73609C			
				
			84320 84321	
		BK111	73608C	Landside, coated short R&L
		BK111	73609C	Landside, coated long R&L
Parts to mount on landsides				
				
63600A	63601A			
				
			1349408 1349409	
				
			800MOL 801MOL	
		BK094	63600A	Wearing plate, rev. R&L
		BK094	63601A	Wearing plate, rev. R&L
		BK052	1349408	Sword coulter R
		BK052	1349409	Sword coulter L
		BK096	800MOL	Subsoiler blade R
		BK096	801MOL	Subsoiler blade L

Parts to fit:

KVERNELAND ploughbodies no. 20 and 30

	<u>Bolt box no.</u>	<u>Article-no.</u>	<u>Designation</u>
Accessories			
73/63-300 73/63-301		BK167 73/63-300 BK167 73/63-301	Turbo-trashboard R Turbo-trashboard L
		73/63-310 73/63-311	Fittings for trashboard R Fittings for trashboard L
Shares, point and accessories			
073054 073055		BK113 073054 BK113 073055	EUROSHARE 14" R EUROSHARE 14" L
073056 073057		BK113 073056 BK113 073057	EUROSHARE 16" R EUROSHARE 16" L
073080 073081		BK113 073080 BK113 073081	EUROSHARE 18" R EUROSHARE 18" L
073084 073085		BK113 073084 BK113 073085	EUROSHARE 20" R EUROSHARE 20" L
		BK095 73091 BK095 73092	Share knife R Share knife L
		BK094 53090 BK094 63090	EUROPOINT Rev. R EUROPOINT Rev. L
		BK095 5309MOLC BK095 6309MOLC	EUROCARBIDE M3 point R EUROCARBIDE M3 point L
MOL83018C MOL83019C		BK170 83018 BK170 83019	EUROSHARE M5 16" R EUROSHARE M5 16" L
83018 83019		BK170 83020 BK170 83021	EUROSHARE M5 18" R EUROSHARE M5 18" L
83020 83021		BK170 83022 BK170 83023	EUROSHARE M5 20" R EUROSHARE M5 20" L
83022 83023		BK111 83012C BK111 83013C	EUROCARBIDE M5 point R EUROCARBIDE M5 point L
		BK111 MOL83-2 BK111 MOL83-3	M7-adaptor R M7-adaptor L
		BK111 MOL83	M7 point rev. R/L
		4879058	Wedge for M7 point
		BK170 MOL83018C BK170 MOL83019C	EUROCARBIDESHARE M5 16" R EUROCARBIDESHARE M5 16" L

Did you know...



that you will reduce mounting time by using Mølbros M5 system as the carbide coated EUROCARBID M5 point will last just as long as the share.



Parts to fit:

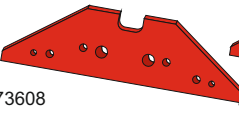
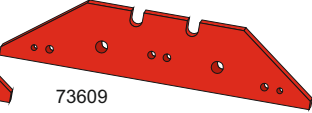
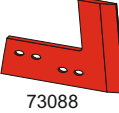
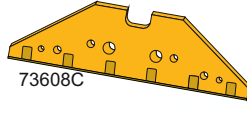
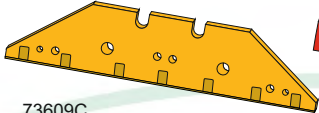
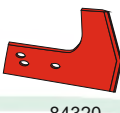

KVERNELAND ploughbodies no. 20 and 30

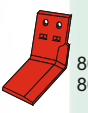
Landsides and share knives		Bolt box no.	Article-no.	Designation
			BK111 73608 BK111 73609 BK110 73088 BK110 73089 BK110 84320 BK110 84321	Landside, short R&L Landside, long R&L Share knife R Share knife L Share knife R Share knife L
73608	73609	73088 73089		
			BK111 73608C BK111 73609C	Landside, coated short R&L Landside, coated long R&L
73608C	73609C	84320 84321		

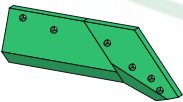

Parts to mount on landsides				
				BK094 63600A BK094 63601A BK052 1349408 BK052 1349409 BK096 800MOL BK096 801MOL
63600A	63601A	1349408 1349409	800MOL 801MOL	Wearing plate, rev. R&L Wearing plate, rev. R&L Sword coulter R Sword coulter L Subsoiler blade R Subsoiler blade L

Parts to fit:

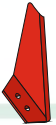
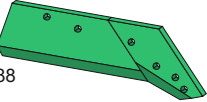
KVERNELAND ploughbody serie 53

Shares, point and accessories				
				BK095 73091 BK094 53090 BK095 5309MOLC
53087	53090	5309MOLC	73091	Share knife R EUROPOINT rev. R EUROCARBIDE M3 point R
				BK100 53087 BK100 53088
53088				EUROSHARE f/rev.point 14" R EUROSHARE f/rev.point 16" R

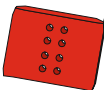
Landsides				
			BK118 53684	Landside, short R
53684				

Parts to mount on landsides				
				BK094 63600A BK094 63601A BK052 1349408 BK096 800MOL
63600A	63601A	1349408	800MOL	Wearing plate, rev. R&L Wearing plate, rev. R&L Sword coulter R Subsoiler blade R



Parts to fit:

KVERNELAND ploughbody ECOMAT

		<u>Bolt box no.</u>	<u>Article-no.</u>	<u>Designation</u>
Shares, point and accessories				
073002 073003				BK113 073002 EUROSHARE 14" R BK113 073003 EUROSHARE 14" L
073004 073005		53090 63090	5309MOLC 6309MOLC	BK113 073004 EUROSHARE 16" R BK113 073005 EUROSHARE 16" L BK114 073006 EUROSHARE 18" R BK114 073007 EUROSHARE 18" L BK114 073008 EUROSHARE 20" R BK114 073009 EUROSHARE 20" L
073006 073007				BK170 83018 EUROSHARE M5 16" R BK170 83019 EUROSHARE M5 16" L BK170 83020 EUROSHARE M5 18" R BK170 83021 EUROSHARE M5 18" L BK170 83022 EUROSHARE M5 20" R BK170 83023 EUROSHARE M5 20" L
073008 073009		73414 73415		BK111 83010C EUROCARBIDE M5 point R BK111 83011C EUROCARBIDE M5 point L BK111 MOL83-0 M7-adapter R BK111 MOL83-1 M7-adapter L MOL83 M7 point rev. R/L 4879058 Wegde for M7 point
MOL83018C MOL83019C		83012C 83013C		BK095 73091 Share knife R BK095 73092 Share knife L BK094 53090 EUPOPOINT Rev. R BK094 63090 EUPOPOINT Rev. L BK095 5309MOLC EUROCARBIDE M3 point R BK095 6309MOLC EUROCARBIDE M3 point L
83018 83019		MOL83-0 MOL83-1		73414 Bracket for 18" and 20" shares R 73415 Bracket for 18" and 20" shares L
83020 83021		MOL83		BK170 MOL83018C EUROCARBIDESHARE M5 16" R BK170 MOL83019C EUROCARBIDESHARE M5 16" L
83022 83023		4879058		
Landsides and share knives				
73608				BK111 73608 Landside, short R&L BK111 73608C Landside, coated short R&L
73608C		84320 84321		BK110 84320 Share knife R BK110 84321 Share knife L
Parts to mount on landsides				
63600A				BK094 63600A Wearing plate, rev. R&L BK094 63601A Wearing plate, rev. R&L
63601A				BK052 1349408 Sword coulter R BK052 1349409 Sword coulter L BK096 800MOL Subsoiler blade R BK096 801MOL Subsoiler blade L
1349408 1349409				
800MOL 801MOL				

Parts to fit:

KVERNELAND ploughs

Bolt box no. Article-no. Designation

Skim shares, skim mouldboards and accesories

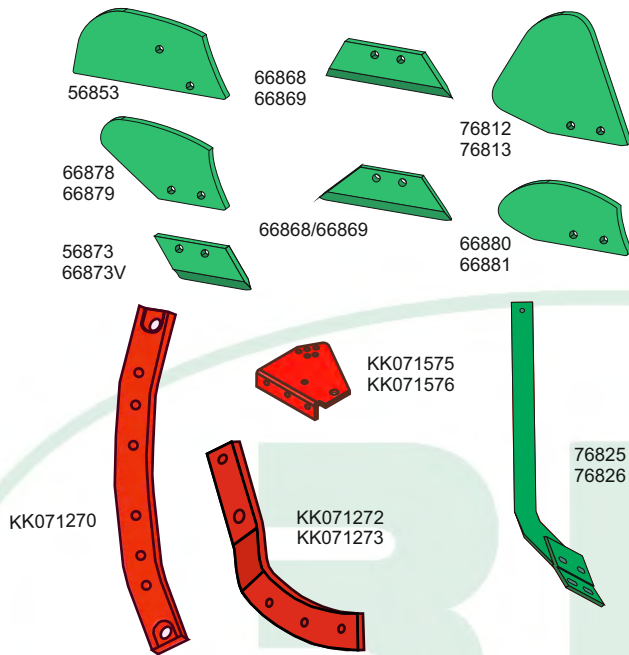

BK026	56853	Skim mouldboard R
BK026	66878	Skim mouldboard R
BK026	66879	Skim mouldboard L
BK026	76812	Skim mouldboard R
BK026	76813	Skim mouldboard L
BK026	66880	Skim mouldboard R
BK026	66881	Skim mouldboard L
BK004	56873	Skim share, short R
BK004	66873V	Skim share, short L
BK004	66868	Skim share, long R
BK004	66869	Skim share, long L
BK004	66868/66869	Skim share, R&L
	76825	Beam R 800mm
	76826	Beam L 800mm
	KK071575	Adapter plade beam bottom
	KK071576	Adapter plade beam top
	KK071270	Beam 800mm center
	KK071272	Beam R
	KK071273	Beam L

Disc coulters and accessories

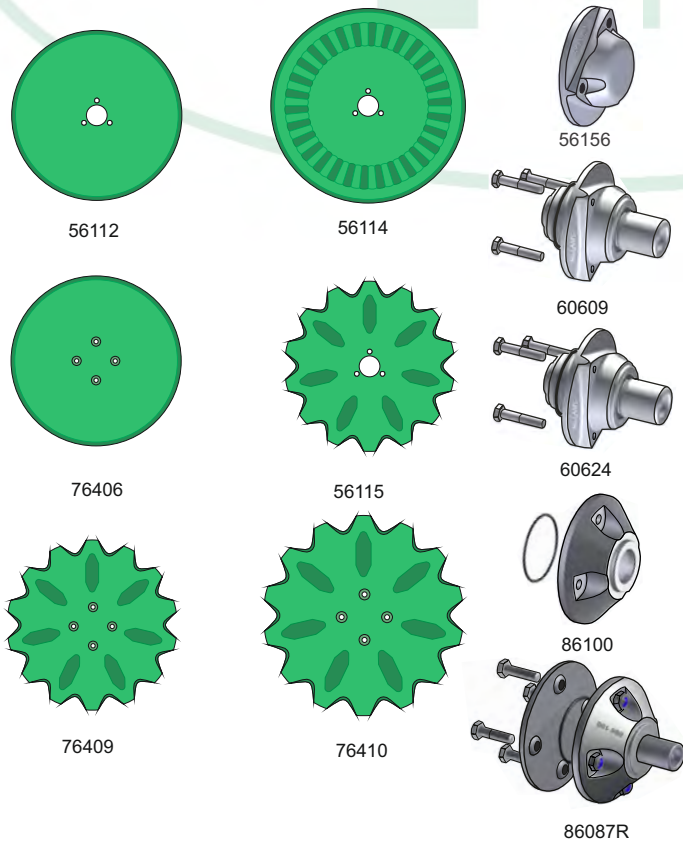

	56112	Disc coultter, 18"
	56114	Disc coultter, rippled 20"
	56115	Disc coultter, notched 18"
	76406	Disc coultter 18"
	76409	Disc coultter 18"
	76410	Disc coultter 20"
	56156	Universal cover for hub
	60609	Hub disc coultter Ø34mm
	60624	Hub disc coultter Ø30mm
	86100	Hub for disc coultter
	86087R	Hub disc coultter











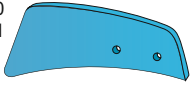
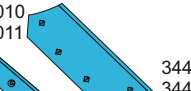
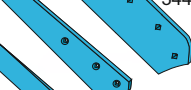

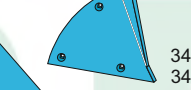



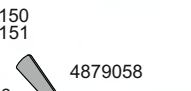



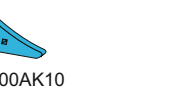

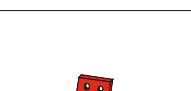
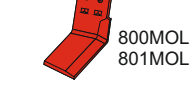

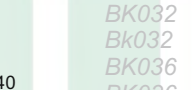







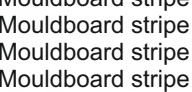
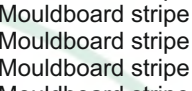
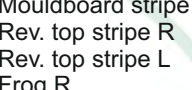

Parts to fit:

LEMKEN B ploughbody

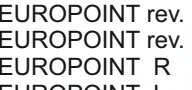
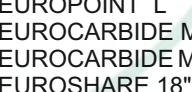
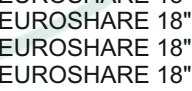
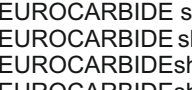
	Bolt box no.	Article-no.	Designation
Mouldboards, shins and accessories			
		<i>BK009</i> 3470860	Turbo-trashboard R
		<i>BK009</i> 3470861	Turbo-trashboard L
		<i>BK013</i> 3476000	Mouldboard extension R
		<i>BK013</i> 3476001	Mouldboard extension L
		<i>BK005</i> 3441034	Mouldboard R
		<i>BK005</i> 3441035	Mouldboard L
		<i>BK019</i> 3441040	Mouldboard R
		<i>BK019</i> 3441041	Mouldboard L
		475MOLR	Brace fitting R
		475MOLL	Brace fitting L
		570MOL	Support for mouldboard
		3451000	Shin R
		3451001	Shin L
		3451002	Shin R (10mm)
		3451003	Shin L (10mm)
		3451010	Shin R (8mm)
		3451011	Shin L (8mm)
		4671002	Frog R
		4671003	Frog L
		4671010	Frog R
		4671011	Frog L
Shares and points			
		<i>BK032</i> 3365540	EUROPOINT rev. R
		<i>BK032</i> 3365541	EUROPOINT rev. L
		<i>BK036</i> 3364050	EUROPOINT R
		<i>BK036</i> 3364051	EUROPOINT L
		<i>BK036</i> 3364150	EUROCARBIDE M5 point R
		<i>BK036</i> 3364151	EUROCARBIDE M5 point L
		<i>BK036</i> 3352010	EUROSHARE 14" R
		<i>BK036</i> 3352011	EUROSHARE 14" L
		<i>BK036</i> 3352020	EUROSHARE 16" R
		<i>BK036</i> 3352021	EUROSHARE 16" L
		<i>BK036</i> 3352030	EUROSHARE 18" R
		<i>BK036</i> 3352031	EUROSHARE 18" L
		<i>BK036</i> 3352130	EUROSHARE 18" R (11mm)
		<i>BK036</i> 3352131	EUROSHARE 18" L (11mm)
		<i>BK036</i> MOL4150	M7-Adapter R
		<i>BK036</i> MOL4151	M7-Adapter L
		<i>BK036</i> MOL83	M7 point
		<i>BK036</i> 4879058	Wedge for M7 point
		<i>BK038</i> MOL2030C	EUROCARBIDE share 18" R
		<i>BK038</i> MOL2031C	EUROCARBIDE share 18" L
		<i>BK036</i> 3352230	EUROCARBIDESHARE M5 18" R
		<i>BK036</i> 3352231	EUROCARBIDESHARE M5 18" L
Landsides and share knives			
		<i>BK008</i> 3401900AK10	Landside, front R
		<i>BK008</i> 3401901AK10	Landside, front L
		<i>BK036</i> 3411500	Landside, short R&L
		<i>BK036</i> 3411504	Landside, long R&L
		<i>BK037</i> 3411508	Landside, tall R&L
		<i>BK037</i> 3411460	Landside, tall R&L
		<i>BK003</i> 3492890	Share knife R
		<i>BK003</i> 3492891	Share knife L
Parts to mount on landsides			
		<i>BK094</i> 63600A	Wearing plate, rev. R&L
		<i>BK094</i> 63601A	Wearing plate, rev. R&L
		<i>BK052</i> 1349408	Sword coulter R
		<i>BK052</i> 1349409	Sword coulter L
		<i>BK096</i> 800MOL	Subsoiler blade R
		<i>BK096</i> 801MOL	Subsoiler blade L

Parts to fit:

LEMKEN BS 40 ploughbody

	Bolt box no.	Article-no.	Designation
Mouldboards, shins and accessories			
	BK009	3470860	Turbo-trashboard R
	BK009	3470861	Turbo-trashboard L
	BK141	469MOL-R	Stay with support R
	BK141	469MOL-L	Stay with support L
		567MOL	Support for stay, short
		568MOL	Support for stay, long
	BK007	3451002	Shin R (10mm)
	BK007	3451003	Shin L (10mm)
	BK010	3451010	Shin R (8mm)
	BK010	3451011	Shin L (8mm)
	BK172	3444010	Mouldboard stripe R
	BK172	3444011	Mouldboard stripe L
	BK172	3444020	Mouldboard stripe R
	BK172	3444021	Mouldboard stripe L
	BK172	3444030	Mouldboard stripe R
	BK172	3444031	Mouldboard stripe L
	BK172	3444040	Mouldboard stripe R
	BK172	3444041	Mouldboard stripe L
	BK006	3444012	Rev. top stripe R
	BK006	3444013	Rev. top stripe L
	BK140	4671002	Frog R
	BK140	4671003	Frog L
	BK140	4671010	Frog R
	BK140	4671011	Frog L
Shares and points			
	BK032	3365540	EUROPOINT rev. R
	BK032	3365541	EUROPOINT rev. L
	BK036	3364050	EUROPOINT R
	BK036	3364051	EUROPOINT L
	BK036	3364150	EUROCARBIDE M5 point R
	BK036	3364151	EUROCARBIDE M5 point L
	BK036	3352030	EUROSHARE 18" R
	BK036	3352031	EUROSHARE 18" L
	BK036	3352130	EUROSHARE 18" R (11mm)
	BK036	3352131	EUROSHARE 18" L (11mm)
	BK038	MOL2030C	EUROCARBIDE share 18" R
	BK038	MOL2031C	EUROCARBIDE share 18" L
	BK036	3352230	EUROCARBIDEshare M5 18" R
	BK036	3352231	EUROCARBIDEshare M5 18" L
	BK036	MOL4150	M7-Adapter R
	BK036	MOL4151	M7-Adapter L
		MOL83	M7 point
		4879058	Wedge for M7 point
Landsides and share knives			
	BK008	3401900AK10	Landside, front R
	BK008	3401901AK10	Landside, front L
	BK036	3411500	Landside, short R&L
	BK036	3411504	Landside, long R&L
	BK037	3411508	Landside, tall R&L
	BK037	3411460	Landside, tall R&L
	BK003	3492890	Share knife R
	BK003	3492891	Share knife L
Parts to mount on landsides			
	BK094	63600A	Wearing plate, rev. R&L
	BK094	63601A	Wearing plate, rev. R&L
	BK052	1349408	Sword coulter R
	BK052	1349409	Sword coulter L
	BK096	800MOL	Subsoiler blade R
	BK096	801MOL	Subsoiler blade L

Parts to fit:

LEMKEN BS 42 ploughbody

	Bolt box no.	Article-no.	Designation
Mouldboards, shins and accessories			
		3470860	BK009 3470860 Turbo-trashboard R
		3470861	BK009 3470861 Turbo-trashboard L
		4695600	BK141 469MOL-R Stay with support R
		4695601	BK141 469MOL-L Stay with support L
		567MOL	4695600 Stay R
		568MOL	4695601 Stay L
		BK007 3451002	567MOL Support for stay, short
		BK007 3451003	568MOL Support for stay, long
		BK007 3451002	BK007 3451002 Shin R (10mm)
		BK007 3451003	BK007 3451003 Shin L (10mm)
		BK010 3451010	BK010 3451010 Shin R (8mm)
		BK010 3451011	BK010 3451011 Shin L (8mm)
		BK172 3444010	BK172 3444010 Mouldboard stripe R
		BK172 3444011	BK172 3444011 Mouldboard stripe L
		BK172 3444020	BK172 3444020 Mouldboard stripe R
		BK172 3444021	BK172 3444021 Mouldboard stripe L
		BK172 3444030	BK172 3444030 Mouldboard stripe R
		BK172 3444031	BK172 3444031 Mouldboard stripe L
		BK173 3444042	BK173 3444042 Mouldboard stripe R
		BK173 3444043	BK173 3444043 Mouldboard stripe L
		BK006 3444012	BK006 3444012 Rev. top stripe R
		BK006 3444013	BK006 3444013 Rev. top stripe L
		BK140 4671002	BK140 4671002 Frog R
		BK140 4671003	BK140 4671003 Frog L
		BK140 4671010	BK140 4671010 Frog R
		BK140 4671011	BK140 4671011 Frog L
Shares and points			
		BK032 3365540	BK032 3365540 EUROPOINT rev. R
		BK032 3365541	BK032 3365541 EUROPOINT rev. L
		BK036 3364050	BK036 3364050 EUROPOINT R
		BK036 3364051	BK036 3364051 EUROPOINT L
		BK036 3364150	BK036 3364150 EUROCARBIDE M5 point R
		BK036 3364151	BK036 3364151 EUROCARBIDE M5 point L
		BK037 3352034	BK037 3352034 EUROSARE 20" R
		BK037 3352035	BK037 3352035 EUROSARE 20" L
		BK037 3352134	BK037 3352134 EUROSARE 20" R (11mm)
		BK037 3352135	BK037 3352135 EUROSARE 20" L (11mm)
		BK036 MOL4150	BK036 MOL4150 M7-Adapter R
		BK036 MOL4151	BK036 MOL4151 M7-Adapter L
		MOL83	MOL83 M7 point
		4879058	4879058 Wedge for M7 point
		BK039 MOL2034C	BK039 MOL2034C EUROCARBIDE share 20" R
		BK039 MOL2035C	BK039 MOL2035C EUROCARBIDE share 20" L
		BK037 3352234	BK037 3352234 EUROCARBIDEshare M5 20" R
		BK037 3352235	BK037 3352235 EUROCARBIDEshare M5 20" L
Landsides and share knives			
		BK008 3401900AK10	BK008 3401900AK10 Landside, front R
		BK008 3401901AK10	BK008 3401901AK10 Landside, front L
		BK036 3411500	BK036 3411500 Landside, short R&L
		BK036 3411504	BK036 3411504 Landside, long R&L
		BK037 3411508	BK037 3411508 Landside, tall R&L
		BK037 3411460	BK037 3411460 Landside, tall R&L
		BK003 3492890	BK003 3492890 Share knife R
		BK003 3492891	BK003 3492891 Share knife L
Parts to mount on landsides			
		BK094 63600A	BK094 63600A Wearing plate, rev. R&L
		BK094 63601A	BK094 63601A Wearing plate, rev. R&L
		BK052 1349408	BK052 1349408 Sword coulter R
		BK052 1349409	BK052 1349409 Sword coulter L
		BK096 800MOL	BK096 800MOL Subsoiler blade R
		BK096 801MOL	BK096 801MOL Subsoiler blade L

Parts to fit:

LEMKEN BU ploughbody

	Bolt box no.	Articel-no.	Designation
Shares and points			
 3351956 3351957 3363986 3363987 3365540 3365541	BK036	3351956	EUROSHARE 14" R
	BK036	3351957	EUROSHARE 14" L
	BK036	3363986	EUROPOINT rev. R
	BK036	3363987	EUROPOINT rev. L
	BK032	3365540	EUROPOINT R
	BK032	3365541	EUROPOINT L
Landsides			
 3401570	BK044	3401570	Landside, semilong R&L

Parts to fit:

LEMKEN CS Duramaxx ploughbody

Landsides			
 3411525 3401903		3411525	Landside R&L
		3401903	Landside, front R&L

Parts to fit:

LEMKEN ploughs

Skim shares and skim mouldboards			
 3470650 3470651 3363720 3363721 3363712 3363713 3363710 3363711 3470600 3470601 3363724	BK001	3470650	Skim mouldboard R
	BK001	3470651	Skim mouldboard L
	BK003	3363720	Skim share R
	BK003	3363721	Skim share L
	BK003	3363710	Skim share R
	BK003	3363711	Skim share L
	BK003	3363712	Skim share R
	BK003	3363713	Skim share L
	BK001	3470600	Skim mouldboard R
	BK001	3470601	Skim mouldboard L
BK003	3363724	Skim share R&L	

Disc coulters			
 3490042 3490029 3490466 3490467		3490042	Disc coulters, notched Ø500mm
		3490029	Disc coulters, plain Ø500mm
		3490466	Disc coulters, concave, notched Ø625mm
		3490467	Disc coulters, concave, notched Ø625mm

Parts to fit:

LEMKEN C and C40 ploughbodies

	<u>Bolt box no.</u>	<u>Article-no.</u>	<u>Designation</u>	
Mouldboards, shins and accessories				
	BK005	3441140	Mouldboard R	
	BK005	3441141	Mouldboard L	
	BK007	3451004	Shin R	
	BK007	3451005	Shin L	
	BK009	3470860	Turbo-trashboard R	
	BK009	3470861	Turbo-trashboard L	
	Shares and points			
		BK032	3365540	EUROPOINT rev. R
		BK032	3365541	EUROPOINT rev. L
BK036		3364054	EUROPOINT R	
BK036		3364055	EUROPOINT L	
BK036		3364154	EUROCARBIDE M5 point R	
BK036		3364155	EUROCARBIDE M5 point L	
BK036		3352010	EUROSHARE 14" R	
BK036		3352011	EUROSHARE 14" L	
BK036		3352020	EUROSHARE 16" R	
BK036		3352021	EUROSHARE 16" L	
BK036		MOL4054	M7-Adapter R	
BK036		MOL4055	M7-Adapter L	
BK036		MOL83	M7 point	
BK036	4879058	Wedge for M7 point		
Landsides and share knives				
	BK008	3401900AK10	Landside, front R	
	BK008	3401901AK10	Landside, front L	
	BK037	3411508	Landside, tall R&L	
	BK036	3411504	Landside, long R&L	
	BK037	3411460	Landside, tall R&L	
	BK003	3492890	Share knife R	
	BK003	3492891	Share knife L	
	Parts to mount on landsides			
		BK094	63600A	Wearing plate, rev. R&L
BK094		63601A	Wearing plate, rev. R&L	
BK052		1349408	Sword coulter R	
BK052		1349409	Sword coulter L	
BK096		800MOL	Subsoiler blade R	
BK096		801MOL	Subsoiler blade L	

Did you know...

that Mølbros M5 EUROCARBID point is thicker than the original Lemken point.

Parts to fit:

LEMKEN US 35 ploughbody

	Bolt box no.	Article-no.	Designation
Mouldboards, shins and accessories			
571MOL		3444130	BK009 3470860 Turbo-trashboard R
		3444131	BK009 3470861 Turbo-trashboard L
572MOL		3444120	4691MOLR Stay with support R
		3444121	4691MOLL Stay with support L
		3470860	571MOL Support for stay, short
		3470861	572MOL Support for stay, long
		3444134	BK007 3451002 Shin R (10mm)
		3444135	BK007 3451003 Shin L (10mm)
4691MOLR		3444110	BK010 3451010 Shin R (8mm)
4691MOLL		3444111	BK010 3451011 Shin L (8mm)
		3451002	BK006 3444110 Mouldboard stripe R
		3451003	BK006 3444111 Mouldboard stripe L
		3444120	BK172 3444120 Mouldboard stripe R
		3444121	BK172 3444121 Mouldboard stripe L
		3444130	BK172 3444130 Mouldboard stripe R
		3444131	BK172 3444131 Mouldboard stripe L
		3444134	BK172 3444134 Mouldboard stripe R
		3444135	BK172 3444135 Mouldboard stripe L
4671002		4671002	BK140 4671002 Frog R
4671003		4671003	BK140 4671003 Frog L
4671010		4671010	BK140 4671010 Frog R
4671011		4671011	BK140 4671011 Frog L
Shares and points			
3352030		3365540	BK032 3365540 EUROPOINT rev. R
3352031		3365541	BK032 3365541 EUROPOINT rev. L
		3364050	BK036 3364050 EUROPOINT R
		3364051	BK036 3364051 EUROPOINT L
		3365540	BK036 3364150 EUROCARBIDE M5 point R
		3365541	BK036 3364151 EUROCARBIDE M5 point L
3352130		3352030	BK036 3352030 EUROSARE 18" R
3352131		3352031	BK036 3352031 EUROSARE 18" L
		3352130	BK036 3352130 EUROSARE 18" R (11mm)
		3352131	BK036 3352131 EUROSARE 18" L (11mm)
3352230		MOL2030C	BK038 MOL2030C EUROCARBIDE share 18" R
3352231		MOL2031C	BK038 MOL2031C EUROCARBIDE share 18" L
		3352230	BK036 3352230 EUROCARBIDEshare M5 18" R
		3352231	BK036 3352231 EUROCARBIDEshare M5 18" L
		MOL4150	BK036 MOL4150 M7-Adapter R
		MOL4151	BK036 MOL4151 M7-Adapter L
		MOL83	MOL83 M7 point
		4879058	4879058 Wedge for M7 point
Landsides and share knives			
3411460		3401900AK10	BK008 3401900AK10 Landside, front R
		3492890	BK008 3401901AK10 Landside, front L
		3492891	BK036 3411500 Landside, short R&L
		3411504	BK036 3411504 Landside, long R&L
		3411508	BK037 3411508 Landside, tall R&L
3411500		3411460	BK037 3411460 Landside, tall R&L
3411504		3492890	BK003 3492890 Share knife R
3411508		3492891	BK003 3492891 Share knife L
		3401900AK10	
		3401901AK10	
Parts to mount on landsides			
63600A		63600A	BK094 63600A Wearing plate, rev. R&L
63601A		63601A	BK094 63601A Wearing plate, rev. R&L
1349408		1349408	BK052 1349408 Sword coulter R
		1349409	BK052 1349409 Sword coulter L
		800MOL	BK096 800MOL Subsoiler blade R
		801MOL	BK096 801MOL Subsoiler blade L



Parts to fit:

LEMKEN US 40 ploughbody

	Bolt box no.	Article-no.	Designation
Mouldboards, shins and accessories			
	BK009	3470860	Turbo-trashboard R
	BK009	3470861	Turbo-trashboard L
		4691MOLR	Stay with support R
		4691MOLL	Stay with support L
		571MOL	Support for stay, short
		572MOL	Support for stay, long
	BK007	3451002	Shin R (10mm)
	BK007	3451003	Shin L (10mm)
	BK010	3451010	Shin R (8mm)
	BK010	3451011	Shin L (8mm)
	BK006	3444110	Mouldboard stripe R
	BK006	3444111	Mouldboard stripe L
	BK172	3444120	Mouldboard stripe R
	BK172	3444121	Mouldboard stripe L
	BK172	3444130	Mouldboard stripe R
	BK172	3444131	Mouldboard stripe L
	BK173	3444140	Mouldboard stripe R
	BK173	3444141	Mouldboard stripe L
	BK140	4671002	Frog R
	BK140	4671003	Frog L
	BK140	4671010	Frog R
	BK140	4671011	Frog L
Shares and points			
	BK032	3365540	EUROPOINT rev. R
	BK032	3365541	EUROPOINT rev. L
	BK036	3364050	EUROPOINT R
	BK036	3364051	EUROPOINT L
	BK036	3364150	EUROCARBIDE M5 point R
	BK036	3364151	EUROCARBIDE M5 point L
	BK037	3352034	EUROSHARE 20" R
	BK037	3352035	EUROSHARE 20" L
	BK037	3352134	EUROSHARE 20" R (11mm)
	BK037	3352135	EUROSHARE 20" L (11mm)
	BK039	MOL2034C	EUROCARBIDE share 20" R
	BK039	MOL2035C	EUROCARBIDE share 20" L
	BK037	3352234	EUROCARBIDEshare M5 20" R
	BK037	3352235	EUROCARBIDEshare M5 20" L
	BK036	MOL4150	M7-Adapter R
	BK036	MOL4151	M7-Adapter L
		MOL83	M7 point
		4879058	Wegde for M7 point
Landsides and share knives			
	BK008	3401900AK10	Landside, front R
	BK008	3401901AK10	Landside, front L
	BK036	3411500	Landside, short R&L
	BK036	3411504	Landside, long R&L
	BK037	3411508	Landside, tall R&L
	BK037	3411460	Landside, tall R&L
	BK003	3492890	Share knife R
	Bk003	3492891	Share knife L
Parts to mount on landsides			
	BK094	63600A	Wearing plate, rev. R&L
	BK094	63601A	Wearing plate, rev. R&L
	BK052	1349408	Sword coulter R
	BK052	1349409	Sword coulter L
	BK096	800MOL	Subsoiler blade R
	BK096	801MOL	Subsoiler blade L

Parts to fit:

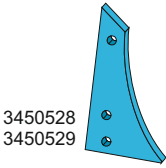
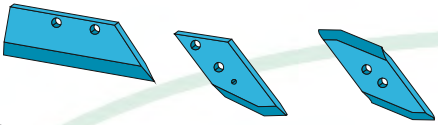
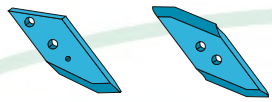
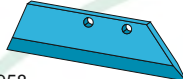
LEMKEN WG ploughbody

	Bolt box no.	Article-no.	Designation
Shins			
 3450528 3450529	BK010	3450528	Shin R
	BK010	3450529	Shin L
Shares and knives			
 3351956 3351957	BK032	3365540	EUROPOINT rev. R
	BK032	3365541	EUROPOINT rev. L
 3363986 3363987	BK036	3363986	EUROPOINT R
	BK036	3363987	EUROPOINT L
 3351958 3351959	BK036	3351956	EUROSHARE 14" R
	BK036	3351957	EUROSHARE 14" L
 3351958 3351959	BK036	3351958	EUROSHARE 16" R
	BK036	3351959	EUROSHARE 16" L

Landside			
 3401570	BK044	3401570	Landside, semi long R&L

Parts to fit:

LEMKEN OPAL ploughbody

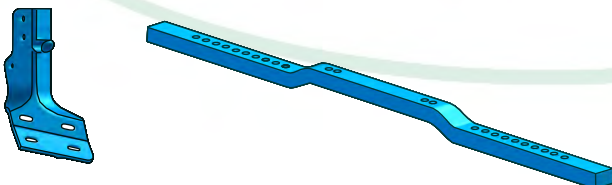
Beams and accesories			
		4570840	Frog 50x30x10 R
		4570841	Frog 50x30x10 L
		4644991	Beam L&R

Parts to fit:

LEMKEN WS ploughbody

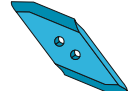
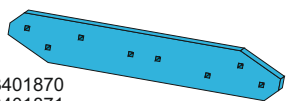
Points			
 3363980 3363981	BK032	3365540	EUROPOINT rev. R
	BK032	3365541	EUROPOINT rev. L
 3365540 3365541	BK036	3363980	EUROPOINT R
	BK036	3363981	EUROPOINT L
Landside			
 3401870 3401871	BK038	3401870	Landside, semilong R
	BK038	3401871	Landside, semilong L

Parts to fit:

MASSEY-FERGUSON FC ploughbody

Numbers in () are original Massey-Ferguson numbers.
Please use art. no. **without** (), when ordering.

Bolt box no. Article-no. Designation

Mouldboards, shins and accessories

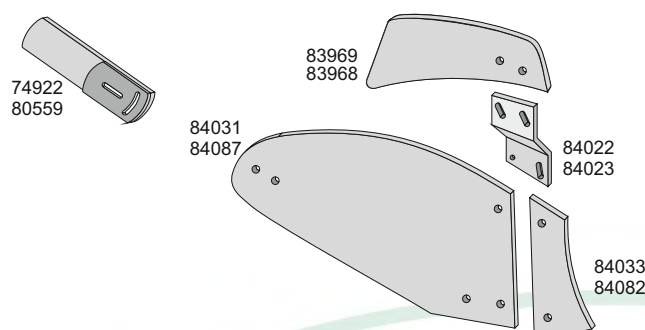

BK167	83969 (3940301)	Turbo-trashboard R
BK167	83968 (3940300)	Turbo-trashboard L
	84022 (3940303)	Fittings for trashboard R
	84023 (3940304)	Fittings for trashboard L
BK062	84031 (3940305)	Mouldboard R
BK062	84087 (3940317)	Mouldboard L
BK082	74922 (3940234)	Mouldboard extension R
BK082	80559 (3940262)	Mouldboard extension L
BK065	84033 (3940306)	Shin R
BK065	84082 (3940315)	Shin L

Shares and points

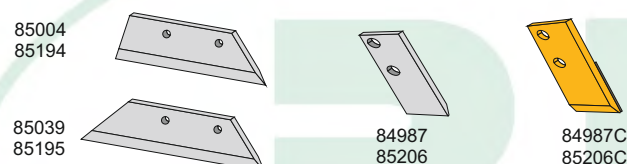

BK052	85004 (3940330)	EUROSHARE 16" R
BK052	85194 (3940334)	EUROSHARE 16" L
BK052	85039 (3940332)	EUROSHARE 18" R
BK052	85195 (3940335)	EUROSHARE 18" L
BK031	84987 (3940328)	EUROPOINT R
BK031	85206 (3940337)	EUROPOINT L
BK031	84987C	EUROCARBIDE M5 point R
BK031	85206C	EUROCARBIDE M5 point L

Landsides and share knives

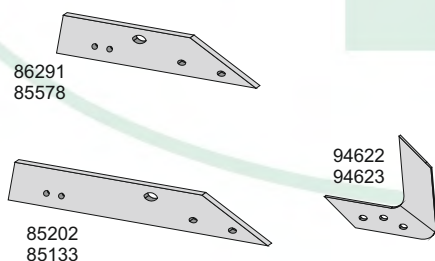

BK084	94622 (3940746)	Share knife R
BK084	94623 (3940745)	Share knife L
BK073	86291 (3940391)	Landside, short R
BK073	85578 (3940359)	Landside, short L
BK073	85202 (3940700)	Landside, long R
BK073	85133 (3940810)	Landside, long L

Parts to mount on landsides

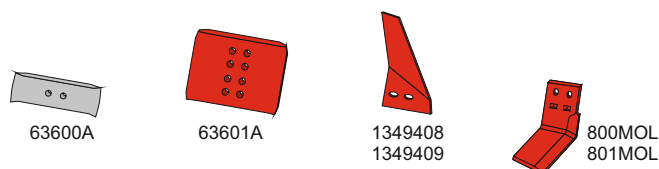

BK094	63600A	Wearing plate, rev. R&L
BK094	63601A	Wearing plate, rev. R&L
BK052	1349408	Sword coultter R
BK052	1349409	Sword coultter L
BK096	800MOL	Subsoiler blade R
BK096	801MOL	Subsoiler blade L

Did you know...

that all Mølbro's landsides are equipped with mounting holes for our full range of landside accessories.

Parts to fit:

MASSEY-FERGUSON AH ploughbody

Numbers in () are original Massey-Ferguson numbers.
Please use art. no. **without** (), when ordering.

Bolt box no. Article-no. Designation

Mouldboards, shins and accessories

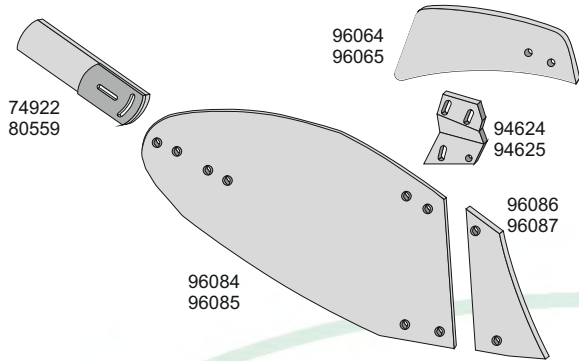

BK082	74922 (3940234)	Mouldboard extension R
BK082	80559 (3940262)	Mouldboard extension L
BK167	96064 (3941789)	Turbo-trashboard R
BK167	96065 (3941790)	Turbo-trashboard L
BK082	94624 (3942733)	Fittings for trashboard R
BK082	94625 (3942732)	Fittings for trashboard L
BK067	96084 (3941973)	Mouldboard R
BK067	96085 (3941972)	Mouldboard L
BK052	96086 (3941975)	Shin R
BK052	96087 (3941974)	Shin L

Shares and points

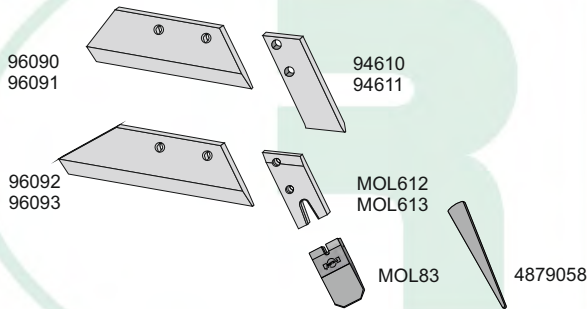

BK052	96090 (39411969)	EUROSHARE 16" R
BK052	96091 (39411968)	EUROSHARE 16" L
BK052	96092 (39411971)	EUROSHARE 18" R
BK052	96093 (39411970)	EUROSHARE 18" L
BK031	94610 (3940742)	EUROPOINT R
BK031	94611 (3940741)	EUROPOINT L
BK031	MOL612	M7-Adapter R
BK031	MOL613	M7-Adapter L
	MOL83	M7 point rev. R/L
	4879058	Wegde for M7 point

Landsides and share knives

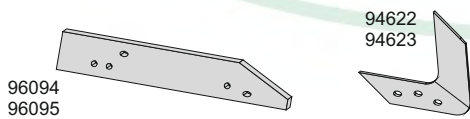

BK069	96094 (39411967)	Landside R
BK069	96095 (39411966)	Landside L
BK084	94622 (3940746)	Share knife R
BK084	94623 (3940745)	Share knife L

Parts to mount on landsides

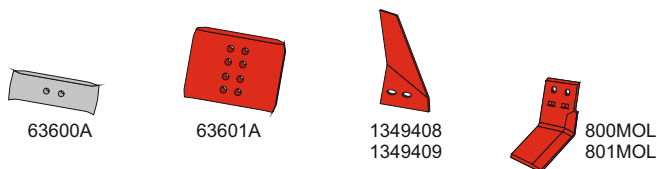

BK094	63600A	Wearing plate, rev. R&L
BK094	63601A	Wearing plate, rev. R&L
BK052	1349408	Sword coulters R
BK052	1349409	Sword coulters L
BK096	800MOL	Subsoiler blade R
BK096	801MOL	Subsoiler blade L

Parts to fit:

MASSEY-FERGUSON AS ploughbody

Numbers in () are original Massey-Ferguson numbers.
Please use art. no. **without** (), when ordering.

Bolt box no. Article-no. Designation

Mouldboards, shins and accessories

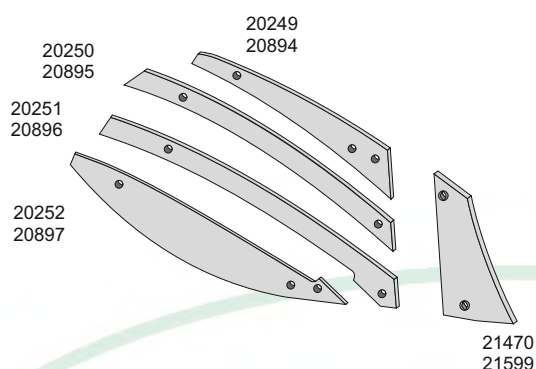

BK058	20249 (3942705)	Mouldboard stripe R
BK058	20894 (3942712)	Mouldboard stripe L
BK052	20250 (3942706)	Mouldboard stripe R
BK052	20895 (3942713)	Mouldboard stripe L
BK052	20251 (3942707)	Mouldboard stripe R
BK052	20896 (3942714)	Mouldboard stripe L
BK058	20252 (3942708)	Mouldboard stripe R
BK058	20897 (3942715)	Mouldboard stripe L
BK052	21470 (3942730)	Shin R
BK052	21599 (3942729)	Shin L

Shares and points

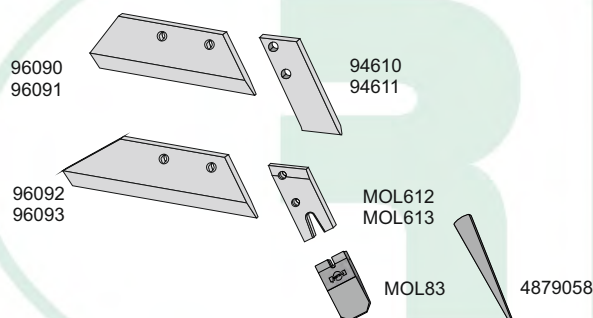

BK052	96090 (39411969)	EUROSHARE 16" R
BK052	96091 (39411968)	EUROSHARE 16" L
BK052	96092 (39411971)	EUROSHARE 18" R
BK052	96093 (39411970)	EUROSHARE 18" L
BK031	94610 (3940742)	EUROPOINT R
BK031	94611 (3940741)	EUROPOINT L
BK031	MOL612	M7-Adapter R
BK031	MOL613	M7-Adapter L
	MOL83	M7 point rev. R/L
	4879058	Wegde for M7 point

Landsides and share knives

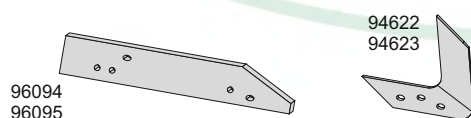

BK069	96094 (39411967)	Landside R
BK069	96095 (39411966)	Landside L
BK084	94622 (3940746)	Share knife R
BK084	94623 (3940745)	Share knife L

Parts to mount on landsides

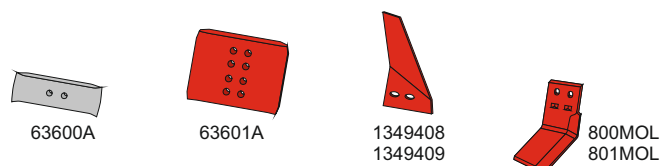

BK094	63600A	Wearing plate, rev. R&L
BK094	63601A	Wearing plate, rev. R&L
BK052	1349408	Sword couler R
BK052	1349409	Sword couler L
BK096	800MOL	Subsoiler blade R
BK096	801MOL	Subsoiler blade L

Parts to fit:

MASSEY-FERGUSON AX ploughbody

Numbers in () are original Massey-Ferguson numbers.
Please use art. no. **without** (), when ordering.

Bolt box no. Article-no. Designation

Mouldboards, shins and accessories

<p>74922 80559</p>	<p>96064 96065</p>	<i>BK082</i> 74922 (3940234) Mouldboard extension R
		<i>BK082</i> 80559 (3940262) Mouldboard extension L
	<p>94624 94625</p>	<i>BK167</i> 96064 (3941789) Turbo-trashboard R
		<i>BK167</i> 96065 (3941790) Turbo-trashboard L
	<p>94594 94595</p>	<i>BK082</i> 94624 (3942733) Fittings for trashboard R
		<i>BK082</i> 94625 (3942732) Fittings for trashboard L
	<p>94596 94597</p>	<i>BK066</i> 94594 (3940744) Mouldboard R
		<i>BK066</i> 94595 (3940743) Mouldboard L
		<i>BK052</i> 94596 (3940704) Shin R
		<i>BK052</i> 94597 (3940705) Shin L

Shares and points

<p>94598 94599</p>	<p>94610 94611</p>	<i>BK052</i> 94598 (3940706) EUROSHARE 14" R
		<i>BK052</i> 94599 (3940707) EUROSHARE 14" L
<p>94600 94601</p>	<p>MOL612 MOL613</p>	<i>BK052</i> 94600 (3940708) EUROSHARE 16" R
		<i>BK052</i> 94601 (3940709) EUROSHARE 16" L
<p>94602 94603</p>	<p>MOL83</p>	<i>BK052</i> 94602 (3940710) EUROSHARE 18" R
		<i>BK052</i> 94603 (3940711) EUROSHARE 18" L
<p>94610 94611</p>	<p>4879058</p>	<i>BK031</i> 94610 (3940742) EUROPOINT R
		<i>BK031</i> 94611 (3940741) EUROPOINT L
		<i>BK031</i> MOL612 M7-Adapter R
		<i>BK031</i> MOL613 M7-Adapter L
		<i>BK031</i> MOL83 M7 point rev. R/L
		<i>BK031</i> 4879058 Wegde for M7 point

Landsides and share knives

<p>96094 96095</p>	<p>94622 94623</p>	<i>BK074</i> 94606 (3940714) Landside R
		<i>BK074</i> 94607 (3940715) Landside L
		<i>BK084</i> 94622 (3940746) Share knife R
		<i>BK084</i> 94623 (3940745) Share knife L

Parts to mount on landsides

<p>63600A</p>	<p>63601A</p>	<p>1349408 1349409</p>	<i>BK094</i> 63600A Wearing plate, rev. R&L
			<i>BK094</i> 63601A Wearing plate, rev. R&L
<p>800MOL 801MOL</p>			<i>BK052</i> 1349408 Sword coulter R
			<i>BK052</i> 1349409 Sword coulter L
			<i>BK096</i> 800MOL Subsoiler blade R
			<i>BK096</i> 801MOL Subsoiler blade L

Parts to fit:

MASSEY-FERGUSON FK ploughbody

Numbers in () are original Massey-Ferguson numbers.
Please use art. no. **without** (), when ordering.

Bolt box no. Article-no. Designation

Mouldboard, shin and accessories

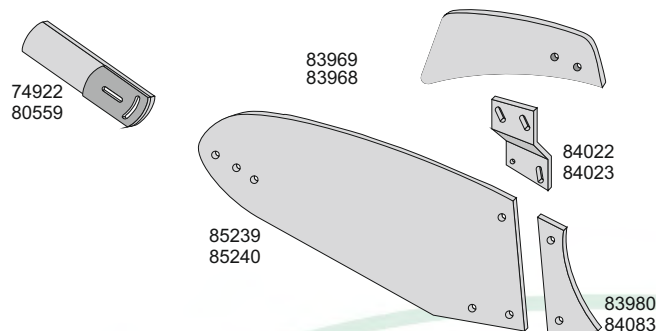

BK167	83969 (3940301)	Turbo-trashboard R
BK167	83968 (3940300)	Turbo-trashboard L
	84022 (3940303)	Fittings for trashboard R
	84023 (3940304)	Fittings for trashboard L
BK063	85239 (3940342)	Mouldboard R
BK063	85240 (3940343)	Mouldboard L
BK082	74922 (3940234)	Mouldboard extension R
BK082	80559 (3940262)	Mouldboard extension L
BK065	83980 (3940302)	Shin R
BK065	84083 (3940316)	Shin L

Shares and points

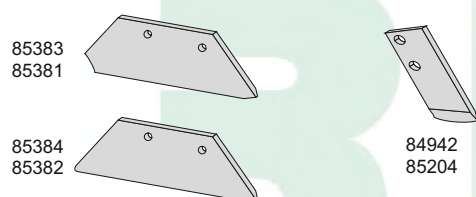

BK052	85383 (3940312)	EUROSHARE 14" R
BK052	85381 (3940314)	EUROSHARE 14" L
BK052	85384 (3940347)	EUROSHARE 16" R
BK052	85382 (3940345)	EUROSHARE 16" L
BK031	84942 (3940326)	EUROPOINT R
BK031	85204 (3940336)	EUROPOINT L

Landsides and share knives

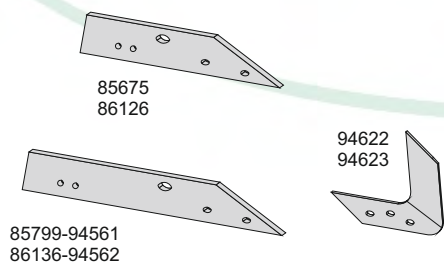

BK084	94622 (3940746)	Share knife R
BK084	94623 (3940745)	Share knife L
BK073	85675 (3940363)	Landside, short R
BK073	86126 (3940385)	Landside, short L
BK073	85799-94561	Landside, long R (3940740)
BK073	86136-94562	Landside, long L (3940701)

Parts to mount on landsides

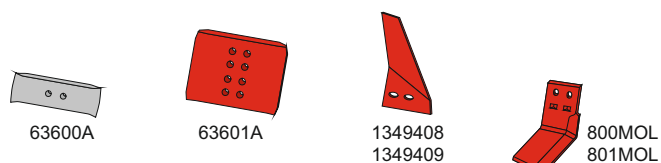

BK094	63600A	Wearing plate, rev. R&L
BK094	63601A	Wearing plate, rev. R&L
BK052	1349408	Sword coulter R
BK052	1349409	Sword coulter L
BK096	800MOL	Subsoiler blade R
BK096	801MOL	Subsoiler blade L

Parts to fit:

MASSEY-FERGUSON ploughs

Numbers in () are original Massey-Ferguson numbers.
Please use art. no. **without** (), when ordering.

Bolt box no. Article-no. Designation

Skim shares and skim mouldboards

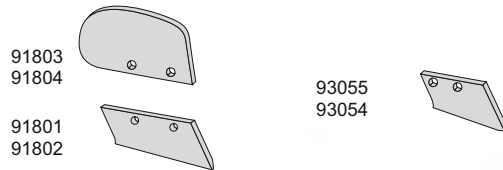

<i>BK052</i>	91803 (3940501)	Skim mouldboard R
<i>BK052</i>	91804 (3940502)	Skim mouldboard L
<i>BK052</i>	91801 (3940499)	Skim share R
<i>BK052</i>	91802 (3940500)	Skim share L
<i>BK052</i>	93055 (3940770)	Skim share R
<i>BK052</i>	93054 (3940771)	Skim share L

Disc coulters and accessories

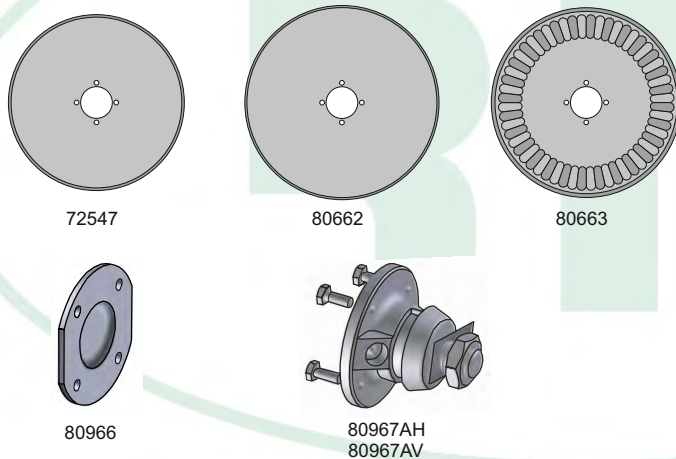

72547 (3940221)	Disc coulters 18" R&L
80662 (3940268)	Disc coulters 20" R&L
80663 (3940269)	Disc coulters, rippled 20" R&L
80966 (3940277)	Cover for disc coulters R&L
80967AH	Hub for disc coulters M30 R
80967AV	Hub for disc coulters M30 L

Parts to fit:

KRONE KG ploughs

Shares and points

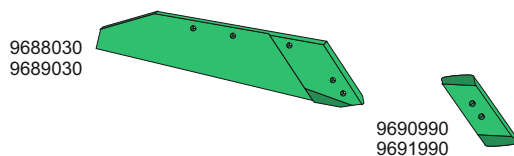

<i>BK099</i>	09688030	EUROSHARE f/rev. point R
<i>BK099</i>	09689030	EUROSHARE f/rev. point L
<i>BK101</i>	09690990	EUROPOINT rev. R
<i>BK101</i>	09691990	EUROPOINT rev. L

Landsides

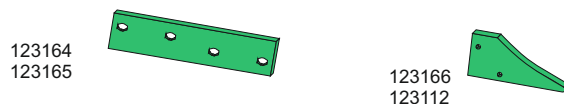

0123164	Landside, long R	
0123165	Landside, long L	
<i>BK098</i>	0123166	Landside, front R
<i>BK098</i>	0123112	Landside, front L

Parts to fit:

NAUD ploughs

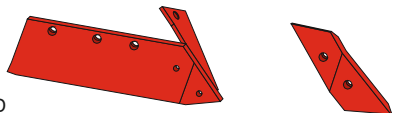
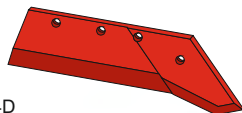
	Bolt box no.	Article-no.	Designation
Shares and points			
 N031189D N031189G		N031189D N031189G	EUROSHARE R EUROSHARE L
		N031235D N031235G	EUROPOINT R EUROPOINT L
 03055504D 03055504G		03055504D 03055504G	EUROSHARE R EUROSHARE L

Landsides and share knives			
 N031190 N031191 N031192		N031190 N031191 N031192	Landside R&L Landside R&L Landside R&L
		N031193D N031193G	Share knife R Share knife L
		N031194D N031194	Share knife R Share knife L

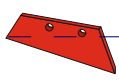
Skim share			
 N031241D N031241G		N031241D N031241G	Skim share Skim share

Parts to fit:

NIEMEYER ploughs

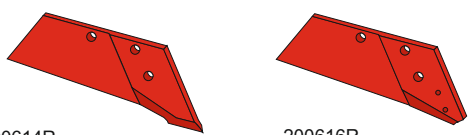
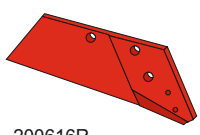
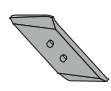
Shares and points			
 200614R 200615L		BK037 200614R BK037 200615L	EUROSHARE R EUROSHARE L
	 200616R 200617L		BK037 200616R BK037 200617L
	 024104R 024105L	BK094 024104R BK094 024105L	EUROPOINT, rev. R EUROPOINT, rev. L

Parts to fit:

PÖTTINGER ploughbodies 36W and 41W

Mouldboards, shins and accessories		Bolt box no.	Article-no.	Designation
73800 73801		BK167	73/63-300	Turbo-trashboard R
53387 63388		BK167	73/63-301	Turbo-trashboard L
73803			73/63-310	Fittings for trashboard R
73290 73291			73/63-311	Fittings for trashboard L
73286 73287		BK156	73803	Brace R&L
73256 73257		BK113	73800	Brace fitting R
		BK113	73801	Brace fitting L
		BK082	53387	Mouldboard extension R
		BK082	63388	Mouldboard extension L
		BK059	73290	Mouldboard R
		BK059	73291	Mouldboard L
		BK056	73286	Mouldboard R
		BK056	73287	Mouldboard L
		BK058	73256	Shin R
		BK058	73257	Shin L
		BK052	73250	Shin R
		BK052	73251	Shin L
			73266	Bracket for shin R
			73267	Bracket for shin L
			93070	Frog R
			93071	Frog L
Shares, points and accessories				
073002 073003		BK113	073002	EUROSHARE 14" R
		BK113	073003	EUROSHARE 14" L
073004 073005		BK113	073004	EUROSHARE 16" R
		BK113	073005	EUROSHARE 16" L
073006 073007		BK114	073006	EUROSHARE 18" R
		BK114	073007	EUROSHARE 18" L
073008 073009		BK114	073008	EUROSHARE 20" R
		BK114	073009	EUROSHARE 20" L
		BK170	83018	EUROSHARE M5 16" R
		BK170	83019	EUROSHARE M5 16" L
		BK170	83020	EUROSHARE M5 18" R
		BK170	83021	EUROSHARE M5 18" L
		BK170	83022	EUROSHARE M5 20" R
		BK170	83023	EUROSHARE M5 20" L
		BK144	83010C	EUROCARBIDE M5 point R
		BK144	83011C	EUROCARBIDE M5 point L
		BK144	MOL83-0	M7-adapter R
		BK144	MOL83-1	M7-adapter L
			MOL83	M7 point rev. R/L
			4879058	Wedge for M7 point
		BK095	73091	Share knife R
		BK095	73092	Share knife L
		BK094	53090	EUROPOINT Rev. R
		BK094	63090	EUROPOINT Rev. L
		BK095	5309MOLC	EUROCARBIDE point R
		BK095	6309MOLC	EUROCARBIDE point L
			73414	Bracket for 18" and 20" shares R
			73415	Bracket for 18" and 20" shares L
		BK170	MOL83018C	EUROCARBIDE M5 share 16" R
		BK170	MOL83019C	EUROCARBIDE M5 share 16" L
Landsides and share knives				
			929100101	Landside, long R&L
		BK095	930700050	Skim point R
		BK095	930710050	Skim point L

Parts to fit:

PÖTTINGER ploughbody 46W

Mouldboards, shins and accessories

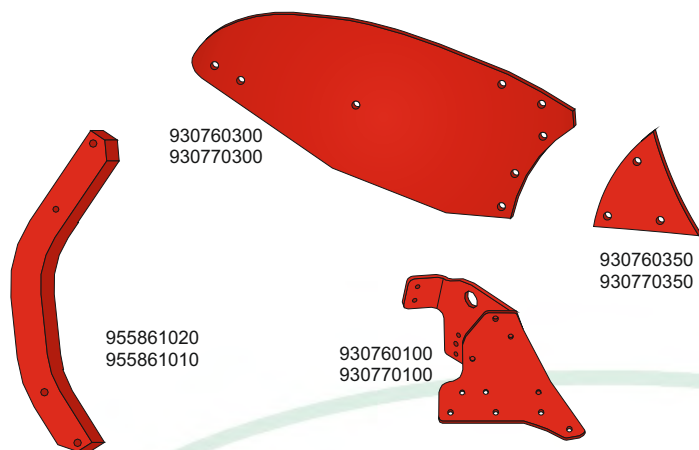

Bolt box no. Article-no. Designation

930760300	Mouldboard R
930770300	Mouldboard L
BK077 930760350	Shin R
BK077 930770350	Shin L
930760100	Frog R
930770100	Frog L
955861020	Beam, R
955861010	Beam, L

Shares, points and accessories

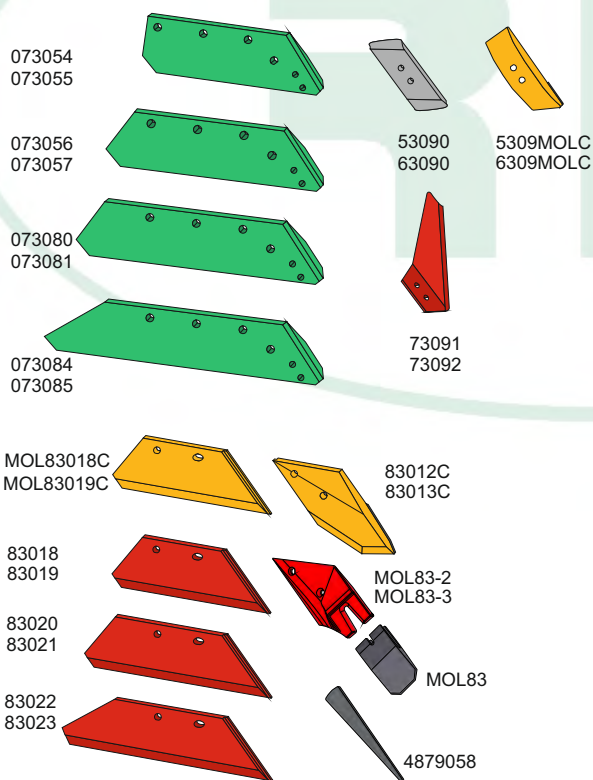

BK113 073054	EUROSHARE 14" R
BK113 073055	EUROSHARE 14" L
BK113 073056	EUROSHARE 16" R
BK113 073057	EUROSHARE 16" L
BK113 073080	EUROSHARE 18" R
BK113 073081	EUROSHARE 18" L
BK113 073084	EUROSHARE 20" R
BK113 073085	EUROSHARE 20" L
BK095 73091	Share knife R
BK092 73092	Share knife L
BK094 53090	EUROPOINT Rev. R
BK094 63090	EUROPOINT Rev. L
BK095 5309MOLC	EUROCARBIDE point R
BK095 6309MOLC	EUROCARBIDE point L
BK170 83018	EUROSHARE M516" R
BK170 83019	EUROSHARE M5 16" L
BK170 83020	EUROSHARE M5 18" R
BK170 83021	EUROSHARE M5 18" L
BK170 83022	EUROSHARE M5 20" R
BK170 83023	EUROSHARE M5 20" L
BK144 83012C	EUROCARBIDE M5 point R
BK144 83013C	EUROCARBIDE M5 point L
BK144 MOL83-0	M7-adapter R
BK144 MOL83-1	M7-adapter L
BK144 MOL83	M7 point rev. R/L
4879058	Wegde for M7 point
BK170 MOL83018C	EUROCARBIDE M5share16" R
BK170 MOL83019C	EUROCARBIDE M5share16" L

Landsides

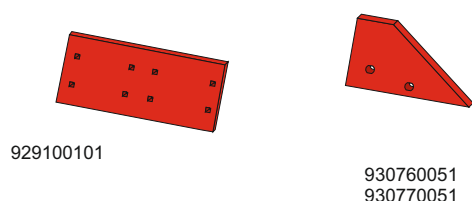

929100101	Landside, long R&L
BK095 930760051	Landside, front R
BK095 930770051	Landside, front L

Parts to fit:

RABEWERK ploughbodies BP-350 WS/WSL

				<u>Bolt box no.</u>	<u>Article-no.</u>	<u>Designation</u>
Mouldboards, shins and accessories						
SRP350W3 2755.03.01	SRP350W2 2755.02.01	SRP350W1 2755.01.01	PDG52 2729.08.01	BK077	PDG52	Trashboard R
SRP350WL3 2755.03.02	SRP350WL2 2755.02.02	SRP350WL1 2755.01.02	PDG52L 2729.08.02	BK077	PDG52L	Trashboard L
SRP350W4 2755.04.01				BK052	SRP350W1	Mouldboard stripe R
SRP350WL4 2755.04.02				BK052	SRP350WL1	Mouldboard stripe L
				BK052	SRP350W2	Mouldboard stripe R
				BK052	SRP350WL2	Mouldboard stripe L
				BK052	SRP350W3	Mouldboard stripe R
				BK052	SRP350WL3	Mouldboard stripe L
				BK052	SRP350W4	Mouldboard stripe R
				BK052	SRP350WL4	Mouldboard stripe L
				BK052	SRP350W41	Mouldboard stripe R
				BK052	SRP350WL41	Mouldboard stripe L
SRP350W41 2755.07.01				BK069	VRP350W	Shin R (10 mm)
SRP350WL41 2755.07.02				BK069	VRP350WL	Shin L (10 mm)
			VRP350W 2758.01.01			
			VRP350WL 2758.01.02			
Shares and Knives						
SSP350WSE 2751.22.01				BK094	MP350	EUROPOINT, rev. R
SSP350WSEL 2751.22.02				BK094	MP350L	EUROPOINT, rev. L
				BK095	MOL350C	EUROCARBIDE M3 point R
				BK095	MOL350LC	EUROCARBIDE M3 point L
		MP350 2751.09.01		BK038	SSP350WSE	EUROSHARE R
		MP350L 2751.09.02		BK038	SSP350WSEL	EUROSHARE L
			MOL350C MOL350LC			
SSP351WEP 2751.30.01				BK038	SSP351WEP	EUROCARBIDE share R
SSP351WEPL 2751.30.02				BK038	SSP351WEPL	EUROCARBIDE share L
Landsides and share knives						
				BK042	WP351W	Landside, rev. R&L
				BK042	VP351W	Landside, short, rev. R&L
				BK041	YP350W	Skim point, rev. R&L
WP351W 2751.03.05	VP351W 2751.03.06	YP350W 2751.02.05				

Did you know...

that Mølbros process around 4000 tons boron steel from Scandinavia every year.

Parts to fit:

RABEWERK ploughbodies BP-2930, 2940 L

	<u>Bolt box no.</u>	<u>Article-no.</u>	<u>Designation</u>
Mouldboards, shins and accessories			
<p>FP78 2701.19.01 FP78L 2701.19.02</p>			
<p>PDG52 2729.08.01 PDG52L 2729.08.02</p>	BK077 BK077	PDG52 PDG52L	Trashboard R Trashboard L
<p>HRP296O 2702.01.01 HRP296OL 2702.01.02</p>			
<p>VRP292R 2701.07.01 VRP292L 2701.07.02</p>	BK058 BK058	FP78 FP78L HRP296O HRP296OL VRP292R VRP292L	Mouldboard extension R Mouldboard extension L Mouldboard R Mouldboard L Shin R Shin L
Shares and points			
<p>SSP293OSE 2701.33.01 SSP293OSEL 2701.33.02</p>	BK094 BK094	MP293 MP293L	EUROPOINT, rev. R EUROPOINT, rev. L
<p>SSP294OSE 2707.04.01 SSP294OSEL 2707.04.02</p>	BK037 BK037 BK037 BK037	MP293 2701.12.01 MP293L 2701.12.02	EUROSHARE R EUROSHARE L EUROSHARE R EUROSHARE L
<p>MOL294C MOL294CL</p>	BK037 BK037	MOL294C MOL294CL	EUROCARBIDE share 18" R EUROCARBIDE share 18" L
Landsides			
<p>VP292O 2701.15.00</p>	BK033	VP292O	Landside, short R&L
<p>WP292O 2701.14.00</p>	BK040	WP292O	Landside, long R&L
Parts to mount on landsides			
<p>63600A</p>	BK094 BK094	63600A 63601A	Wearing plate, rev. R&L Wearing plate, rev. R&L
<p>63601A</p>	BK052 BK052	1349408 1349409	Sword coulter R Sword coulter L
<p>1349408 1349409</p>	BK096 BK096	800MOL 801MOL	Subsoiler blade R Subsoiler blade L
<p>800MOL 801MOL</p>			

Parts to fit:

RABEWERK universal wearing parts

	<u>Bolt box no.</u>	<u>Article-no.</u>	<u>Designation</u>
Shares and points			
SSP332OSE 2708.27.02 SSP332OSEL 2708.27.02		MP332 2708.28.01 MP332L 2708.28.02	<i>BK037</i> SSP332OSE EUROSHARE R <i>BK037</i> SSP332OSEL EUROSHARE L
SSP333OSE 2753.15.01 SSP333OSEL 2753.15.02		PK801101 PK801102	<i>BK037</i> SSP333OSE EUROSHARE R <i>BK037</i> SSP333OSEL EUROSHARE L
SSP200JB 2708.16.01 SSP200JBL 2708.16.02			<i>BK094</i> Mp332 EUROPOINT rev. R <i>BK094</i> MP332L EUROPOINT rev. L
			<i>BK094</i> PK801101 EUROPOINT rev. R <i>BK094</i> PK801102 EUROPOINT rev. L
Skim shares			
SDG14/16 2742.02.01 SDG14/16L 2742.02.02		SDG181 2715.01.01 SDG181L 2715.01.02	<i>BK003</i> SDG14/16 Skim share R <i>BK003</i> SDG14/16L Skim share L
		SDG18 2715.05.01 SDG18L 2715.05.02	<i>BK001</i> SDG181 Skim share R <i>BK001</i> SDG181L Skim share L
			<i>BK001</i> SDG18 Skim share R <i>BK001</i> SDG18L Skim share L
Disc coulters			
			9031.13.29 Disc coulters, notched Ø445mm
			9022.52.11 Disc coulters, notched Ø355mm
			9008.55.10 Disc coulters, Ø300mm

Did you know...

that all Mølbros discs are produced in boron steel quality.

Parts to fit:

RABEWERK universal ploughbody (Lemken)

Mouldboards, shins and accessories		Bolt box no.	Article-no.	Designation	
<p>571MOL</p> <p>572MOL</p> <p>4691MOLLR 4691MOLL</p> <p>2101002 2101003</p> <p>3470860 3470861</p> <p>3444130 3444131</p> <p>3444120 3444121</p> <p>3444110 3444111</p> <p>3444140 3444141</p> <p>3451002 3451003</p> <p>3451010 3451011</p>		BK009	3470860	Turbo-trashboard R	
		BK009	3470861	Turbo-trashboard L	
			4691MOLLR	Stay with support R	
			4691MOLL	Stay with support L	
			571MOL	Support for stay, short	
			572MOL	Support for stay, long	
		BK007	3451002	Shin R (10mm)	
		BK007	3451003	Shin L (10mm)	
		BK010	3451010	Shin R (8mm)	
		BK010	3451011	Shin L (8mm)	
		BK006	3444110	Mouldboard stripe R	
		BK006	3444111	Mouldboard stripe L	
		BK172	3444120	Mouldboard stripe R	
		BK172	3444121	Mouldboard stripe L	
		BK172	3444130	Mouldboard stripe R	
		BK172	3444131	Mouldboard stripe L	
		BK173	3444140	Mouldboard stripe R	
		BK173	3444141	Mouldboard stripe L	
	BK140	2101002	Frog R		
	BK140	2101003	Frog L		
Shares and points					
<p>3352010 3352011</p> <p>3352020 3352021</p> <p>3352030 3352031</p> <p>3352034 3352035</p> <p>3352134 3352135</p> <p>3364050 3364051</p> <p>3365540 3365541</p> <p>MOL4150 MOL4151</p> <p>MOL83</p> <p>4879058</p> <p>3352234 3352235</p> <p>3364150 3364151</p> <p>MOL2034C MOL2035C</p>		BK032	3365540	EUROPOINT rev. R	
		BK032	3365541	EUROPOINT rev. L	
		BK036	3364050	EUROPOINT R	
		BK036	3364051	EUROPOINT L	
		BK036	3364150	EUROCARBIDE M5 point R	
		BK036	3364151	EUROCARBIDE M5 point L	
		BK036	3352010	EUROSHARE 14" R	
		BK036	3352011	EUROSHARE 14" L	
		BK036	3352020	EUROSHARE 16" R	
		BK036	3352021	EUROSHARE 16" L	
		BK036	3352030	EUROSHARE 18" R	
		BK036	3352031	EUROSHARE 18" L	
		BK037	3352034	EUROSHARE 20" R	
		BK037	3352035	EUROSHARE 20" L	
		BK037	3352134	EUROSHARE 20" R (11mm)	
		BK037	3352135	EUROSHARE 20" L (11mm)	
		BK036	MOL4150	M7-Adapter R	
		BK036	MOL4151	M7-Adapter L	
			MOL83	M7 point	
			4879058	Wegde for M7 point	
	BK039	MOL2034C	EUROCARBIDE share 20" R		
	BK039	MOL2035C	EUROCARBIDE share 20" L		
	BK037	3352234	EUROCARBIDE M5 20" R		
	BK037	3352235	EUROCARBIDE M5 20" L		
Landsides and share knives					
<p>3411460</p> <p>3411500</p> <p>3411504</p> <p>3411508</p> <p>3492890 3492891</p> <p>3401900AK10 3401901AK10</p>		BK008	3401900AK10	Landside, front R	
		BK008	3401901AK10	Landside, front L	
		BK036	3411500	Landside, short R&L	
		BK036	3411504	Landside, long R&L	
		BK037	3411508	Landside, tall R&L	
		BK037	3411460	Landside, tall R&L	
		BK003	3492890	Share knife R	
		BK003	3492891	Share knife L	
	Parts to mount on landsides				
	<p>63600A</p> <p>63601A</p> <p>1349408 1349409</p> <p>800MOL 801MOL</p>		BK094	63600A	Wearing plate, rev. R&L
		BK094	63601A	Wearing plate, rev. R&L	
		BK052	1349408	Sword coulter R	
		BK052	1349409	Sword coulter L	
		BK096	800MOL	Subsoiler blade R	
		BK096	801MOL	Subsoiler blade L	

Parts to fit

ROSS/Roudnice nad Labem ploughs

Bolt box no. Article no. Designation

Mouldboards, shins and accessories

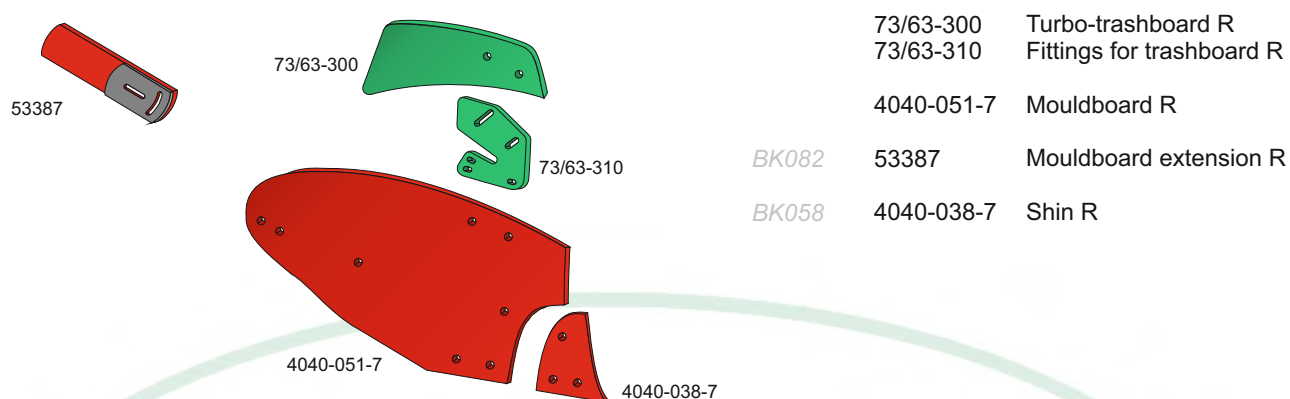

Shares, points and accessories

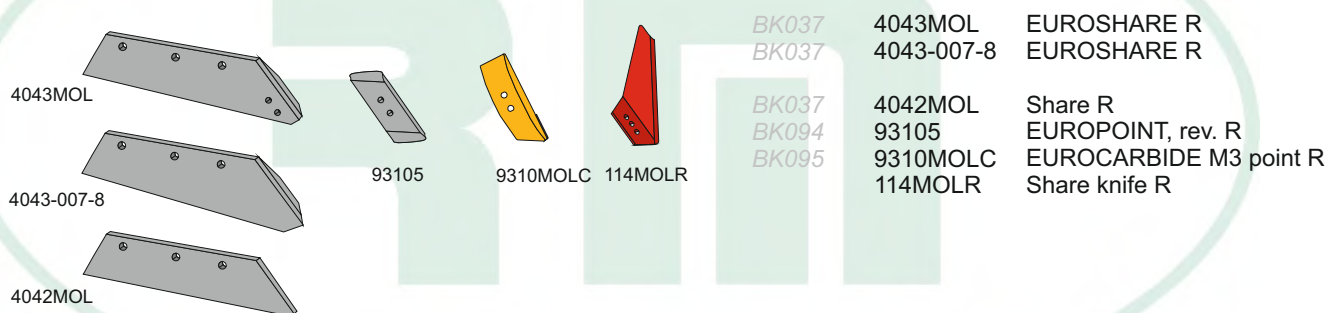

Landsides

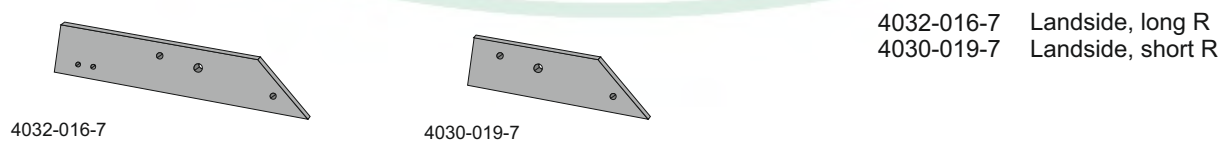

Parts to mount on landsides

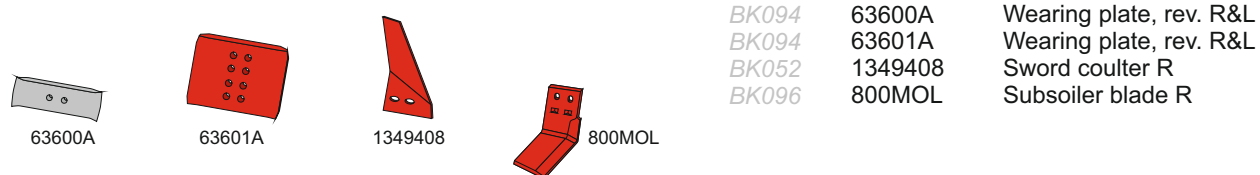

Parts to fit

UNIA ploughs

Bolt box no. Article no. Designation

Mouldboards, shins and accessories

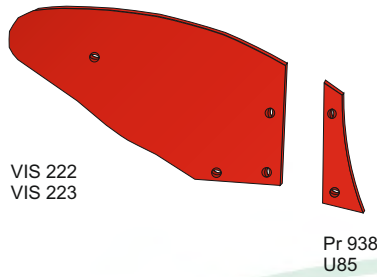

VIS 222 Mouldboard R
VIS 223 Mouldboard L

Pr 938 Shin R
U85 Shin L

Shares, points and accessories

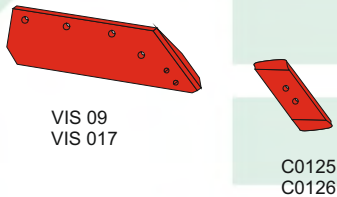

VIS 09
VIS 017

C0125
C0126

BK038 VIS 09 EUROSHARE R
BK038 VIS 017 EUROSHARE L

BK094 C0125 EUROPOINT R
BK094 C0126 EUROPOINT L

Landsides

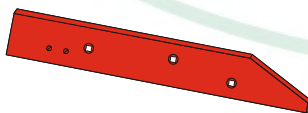

VIS 024
VIS 023

VIS 024 Landside R
VIS 023 Landside L

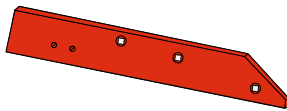

Po 738 Landside R
Po 739 Landside L

Po738
Po739

Parts to mount on landsides

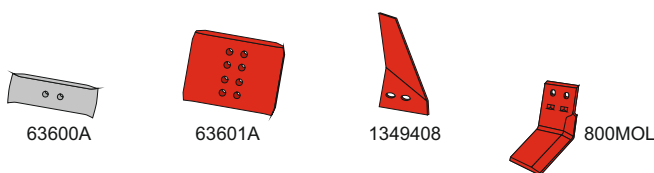

63600A

63601A

1349408

800MOL

BK094 63600A Wearing plate, rev. R&L
BK094 63601A Wearing plate, rev. R&L
BK052 1349408 Sword coulter R
BK096 800MOL Subsoiler blade R

Parts to fit:

VOGEL & NOOT ploughbody UN 400

		<u>Bolt box no.</u>	<u>Article-no.</u>	<u>Designation</u>
Mouldboard and shin				
			PK400102 PK400202	Mouldboard R Mouldboard L
		BK021	PK400103	Shin R
		BK021	PK400203	Shin L
Shares and points				
		BK112	PK401301	EUROSHARE 16" R
		BK112	PK401401	EUROSHARE 16" L
		BK112	PK501301	EUROSHARE 18" R
		BK112	PK501401	EUROSHARE 18" L
		BK094	PK801101R	EUROPOINT, rev. R
		BK094	PK801102L	EUROPOINT, rev. L
Landsides				
			P5801101	Wearing plate R&L
			P8903401	Landside, short R
			P8903501	Landside, short L
			P8903601	Landside, long R
			P8903701	Landside, long L
Parts to mount on landsides				
		BK094	63600A	Wearing plate, rev. R&L
		BK094	63601A	Wearing plate, rev. R&L
		BK052	1349408	Sword coulter R
		BK052	1349409	Sword coulter L
		BK096	800MOL	Subsoiler blade R
		BK096	801MOL	Subsoiler blade L

Parts to fit:

VOGEL & NOOT ploughs

Skim shares				
		BK069	Lz135601	Skim share R
		BK069	LZ135701	Skim share L
		BK026	PA305402	Skim mouldboard R
		BK026	PA305502	Skim mouldboard L

Parts to fit:

VOGEL & NOOT ploughbody WY 400

		Bolt box no.	Article-no.	Designation
Mouldboard, shins and accessories				
		BK024	PK800109	Mouldboard R
		BK024	PK800209	Mouldboard L
		BK022	PK800501	Shin R
		BK022	PK800601	Shin L
		BK167	PK805102	Turbo-trashboard R
		BK167	PK805202	Turbo-trashboard L
			PK800102	Mouldboard extension R
			PK800202	Mouldboard extension L
			PK800501	
			PK800601	
Shares and points				
		BK112	PK601301	EUROSHARE 14" R
		BK112	PK601401	EUROSHARE 14" L
		BK112	PK701301	EUROSHARE 16" R
		BK112	PK701401	EUROSHARE 16" L
		BK094	PK801101R	EUROPOINT, rev. R
		BK094	PK801102L	EUROPOINT, rev. L
Landsides				
			P5801101	Wearing plate, rev. R&L
			P8903401	Landside, short R
			P8903501	Landside, short L
			P8903601	Landside, long R
			P8903701	Landside, long L
Parts to mount on landsides				
		BK094	63600A	Wearing plate, rev. R&L
		BK094	63601A	Wearing plate, rev. R&L
		BK052	1349408	Sword coulter R
		BK052	1349409	Sword coulter L
		BK096	800MOL	Subsoiler blade R
		BK096	801MOL	Subsoiler blade L

Parts to fit

ØVERUM SR ploughbody

	<u>Bolt box no.</u>	<u>Article-no.</u>	<u>Designation</u>
Mouldboard, shin and accessories			
	BK060	80604/85261	Mouldboard R
	BK082	74922	Mouldboard extension R
	BK139	80609	Shin R
		80604 85261	
		80609	
Shares and points			
	BK119	74605	EUROSHARE 12" R
	BK119	74606	EUROSHARE 14" R
	BK119	74607	EUROSHARE 16" R
	BK050	80605-92	EUROSHARE 14" R
	BK050	80605-93	EUROSHARE 16" R
		74601	Point, steel casting R
		76601	Weld-on point R
Landsides			
	BK138	84239	Landside, short R
	BK122	74612	Wearing plate, rev. R
	BK130	74602	Landside, front R
		84239	
Parts to mount on landsides			
	BK094	63600A	Wearing plate, rev. R&L
	BK094	63601A	Wearing plate, rev. R&L
	BK052	1349408	Sword coulter R
	BK096	800MOL	Subsoiler blade R

Parts to fit:

ØVERUM UC ploughbody











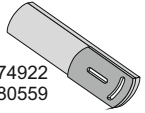
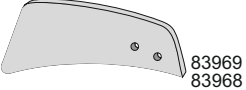

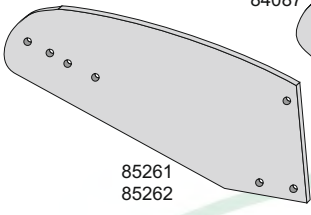

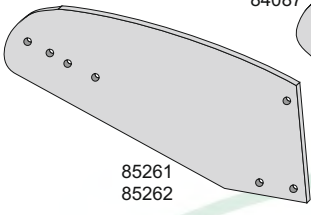



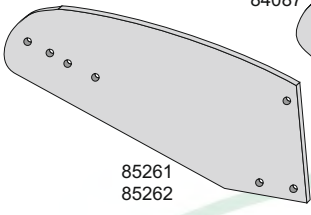

















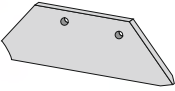





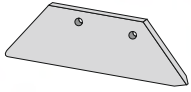





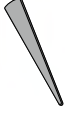













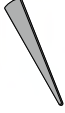
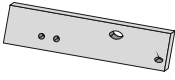
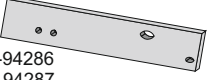
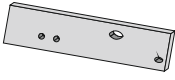
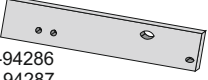
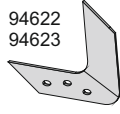
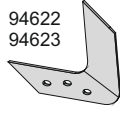

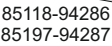



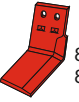

	<u>Bolt box no.</u>	<u>Articel-no.</u>	<u>Designation</u>
Mouldboard, shin and accessories			
	BK167	83969	Turbo-trashboard R
	BK167	83968	Turbo-trashboard L
		84022	Fittings for trashboard R
		84023	Fittings for trashboard L
	BK082	74922	Mouldboard extension R
	BK082	80559	Mouldboard extension L
	BK062	84031	Mouldboard R
	BK062	84087	Mouldboard L
	BK065	84033	Shin R
	BK065	84082	Shin L
Shares and points			
	BK087	92206	EUROPOINT, rev. R
	BK087	92207	EUROPOINT, rev. L
		92206C	EUROCARBIDE M3 point R
		92207C	EUROCARBIDE M3 point L
	BK054	84958	Support R
	BK054	85191	Support L
	BK052	85004	EUROSHARE 16" R
	BK052	85194	EUROSHARE 16" L
	BK052	85039	EUROSHARE 18" R
	BK052	85195	EUROSHARE 18" L
Landsides and share knives			
	BK074	83981	Landside, short R
	BK074	85196	Landside, short L
	BK074	85118-94286	Landside, long R
	BK074	85197-94287	Landside, long L
	BK084	94622	Share knife R
	BK084	94623	Share knife L
Parts to mount on Landsides			
	BK094	63600A	Wearing plate, rev. R&L
	BK094	63601A	Wearing plate, rev. R&L
	BK052	1349408	Sword coulter R
	BK052	1349409	Sword coulter L
	BK096	800MOL	Subsoiler blade R
	BK096	801MOL	Subsoiler blade L

Did you know...

that the carbide coating is always on the backside of Mølbros EUROCARBID points. This gives the point a self-sharpening effect so it always attacks the ground optimal - even if it is almost worn.

Parts to fit:

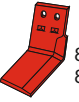
ØVERUM V ploughbody

	Bolt box no.	Article-no.	Designation
Mouldboards, shins and accessories			
	BK167	83969	Turbo-trashboard R
	BK167	83968	Turbo-trashboard L
		84022	Fittings for trashboard R
		84023	Fittings for trashboard L
	BK082	74922	Mouldboard extension R
	BK082	80559	Mouldboard extension L
	BK062	84031	Mouldboard R
	BK062	84087	Mouldboard L
	BK065	84033	Shin R
	BK065	84082	Shin L
	BK064	85261	Mouldboard R
	BK064	85262	Mouldboard L
	BK065	83980	Shin R
	BK065	84083	Shin L
		74922	
		80559	
		83969	
		83968	
		84031	
		84087	
		84022	
		84023	
		84033	
		84082	
		85261	
		85262	
		83980	
		84083	
Shares and points			
	BK069	92206	EUROPOINT, rev. R
	BK069	92207	EUROPOINT, rev. L
	BK069	92206C	EUROCARBIDE M3 point R
	BK069	92207C	EUROCARBIDE M3 point L
	BK055	84288	Support R
	BK055	84289	Support L
	BK052	85383	EUROSHARE 16" R
	BK052	85381	EUROSHARE 16" L
	BK052	85384	EUROSHARE 18" R
	BK052	85382	EUROSHARE 18" L
	BK031	MOL288	M7-Adapter R
	BK031	MOL289	M7-Adapter L
		MOL83	M7 point rev. R/L
		4879058	Wedge for M7 point
		85383	
		85381	
		84288	
		84289	
		92206	
		92207	
		92206C	
		92207C	
		85384	
		85382	
		MOL288	
		MOL289	
		MOL83	
		4879058	
Landsides and share knives			
	BK074	83981	Landside, short R
	BK074	85196	Landside, short L
	BK074	85118-94286	Landside, long R
	BK074	85197-94287	Landside, long L
	BK084	94622	Share knife R
	BK084	94623	Share knife L
		83981	
		85196	
		85118-94286	
		85197-94287	
		94622	
		94623	
Parts to mount on landsides			
	BK094	63600A	Wearing plate, rev. R&L
	BK094	63601A	Wearing plate, rev. R&L
	BK052	1349408	Sword coulter R
	BK052	1349409	Sword coulter L
	BK096	800MOL	Subsoiler blade R
	BK096	801MOL	Subsoiler blade L
		63600A	
		63601A	
		1349408	
		1349409	
		800MOL	
		801MOL	

Parts to fit:

ØVERUM XL ploughbody

Bolt box no. Article-no. Designation

Mouldboards, shins and accessories

	<i>BK167</i>	96064-83969	Turbo-trashboard R
	<i>BK167</i>	96065-83968	Turbo-trashboard L
	<i>BK082</i>	94624	Fittings for trashboard R
	<i>BK082</i>	94625	Fittings for trashboard L
	<i>BK082</i>	74922	Mouldboard extension R
	<i>BK082</i>	80559	Mouldboard extension L
	<i>BK066</i>	94594	Mouldboard R
	<i>BK066</i>	94595	Mouldboard L
	<i>BK052</i>	94596	Shin R
	<i>BK052</i>	94597	Shin L

Shares an points

	<i>BK086</i>	94608	EUROPOINT, rev. R
	<i>BK086</i>	94609	EUROPOINT, rev. L
	<i>BK069</i>	94608C	EUROCARBIDE M3 point R
	<i>BK069</i>	94609C	EUROCARBIDE M3 point L
	<i>BK069</i>	94612	Support R
	<i>BK069</i>	94613	Support L
	<i>BK031</i>	MOL612	M7-Adapter R
	<i>BK031</i>	MOL613	M7-Adapter L
		MOL83	M7 point rev. R/L
		4879058	Wegde for M7 point
	<i>BK052</i>	94598	EUROSHARE 14" R
	<i>BK052</i>	94599	EUROSHARE 14" L
	<i>BK052</i>	94600	EUROSHARE 16" R
	<i>BK052</i>	94601	EUROSHARE 16" L
	<i>BK052</i>	94602	EUROSHARE 18" R
<i>BK052</i>	94603	EUROSHARE 18" L	

Landsides and share knives

	<i>Bk074</i>	94604	Landside R
	<i>BK074</i>	94605	Landside L
	<i>BK084</i>	94622	Share knife R
	<i>BK084</i>	94623	Share knife L

Parts to mount on landsides

	<i>BK094</i>	63600A	Wearing plate, rev. R&L
	<i>BK094</i>	63601A	Wearing plate, rev. R&L
	<i>BK052</i>	1349408	Sword coulter R
	<i>BK052</i>	1349409	Sword coulter L
	<i>BK096</i>	800MOL	Subsoiler blade R
	<i>BK096</i>	801MOL	Subsoiler blade L

Parts to fit:

ØVERUM XS ploughbody

	<u>Bolt box no.</u>	<u>Article-no.</u>	<u>Designation</u>
Mouldboards and shins			
	BK058	20249	Mouldboard stripe R
	BK058	20894	Mouldboard stripe L
	BK052	20250	Mouldboard stripe R
	BK052	20895	Mouldboard stripe L
	BK052	20251	Mouldboard stripe R
	BK052	20896	Mouldboard stripe L
	BK058	20252	Mouldboard stripe R
	BK058	20897	Mouldboard stripe L
	BK052	21470	Shin R
	BK052	21599	Shin L
Shares and points			
	BK086	94608	EUROPOINT, rev. R
	BK086	94609	EUROPOINT, rev. L
	BK069	94608C	EUROCARBIDE M3 point R
	BK069	94609C	EUROCARBIDE M3 point L
	BK069	94612	Support R
	BK069	94613	Support L
	BK052	96090	EUROSHARE 16" R
	BK052	96091	EUROSHARE 16" L
	BK052	96092	EUROSHARE 18" R
	BK052	96093	EUROSHARE 18" L
	BK031	MOL612	M7-Adapter R
	BK031	MOL613	M7-Adapter L
	BK031	MOL83	M7 point rev. R/L
	BK031	4879058	Wedge for M7 point
Landsides and share knives			
	BK069	96094	Landside R
	BK069	96095	Landside L
	BK084	94622	Share knife R
	BK084	94623	Share knife L
Parts to mount on landsides			
	BK094	63600A	Wearing plate, rev. R&L
	BK094	63601A	Wearing plate, rev. R&L
	BK052	1349408	Sword coulter R
	BK052	1349409	Sword coulter L
	BK096	800MOL	Subsoiler blade R
	BK096	801MOL	Subsoiler blade L

Parts to fit:

ØVERUM XU ploughbody

Bolt box no. Articul-no. Designation

Mouldboard, shin and accessories

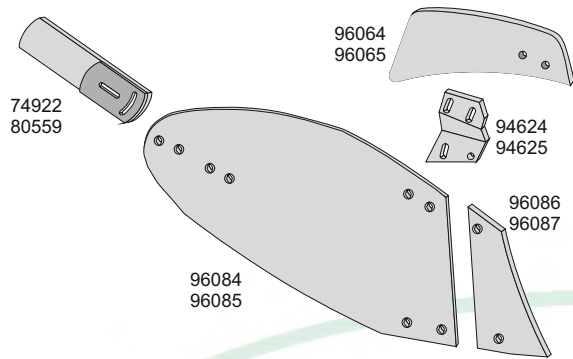

BK167	96064	Turbo-trashboard R
BK167	96065	Turbo-trashboard L
BK082	94624	Fittings for trashboard R
BK082	94625	Fittings for trashboard L
BK082	74922	Mouldboard extension R
BK082	80559	Mouldboard extension L
BK067	96084	Mouldboard R
BK067	96085	Mouldboard L
BK052	96086	Shin R
BK052	96087	Shin L

Shares and points

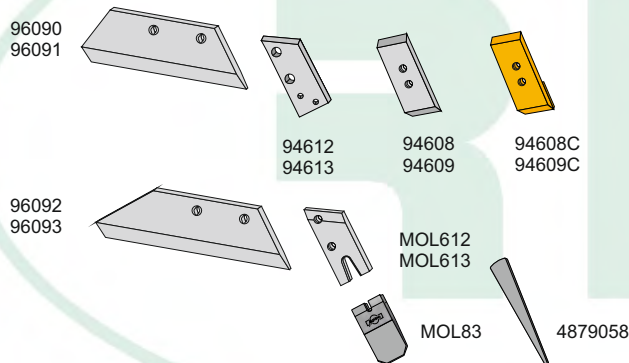

BK069	94608	EUROPOINT, rev. R
BK069	94609	EUROPOINT, rev. L
BK069	94608C	EUROCARBIDE M3 point R
BK069	94609C	EUROCARBIDE M3 point L
BK069	94612	Bracket plate R
BK069	94613	Bracket plate L
BK031	MOL612	M7-Adapter R
BK031	MOL613	M7-Adapter L
	MOL83	M7 point rev. R/L
	4879058	Wegde for M7 point
BK052	96090	EUROSHARE 16" R
BK052	96091	EUROSHARE 16" L
BK052	96092	EUROSHARE 18" R
BK052	96093	EUROSHARE 18" L

Landsides and share knives

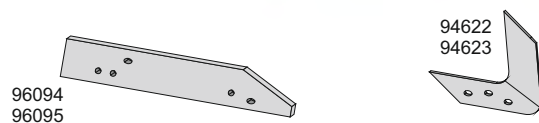

BK069	96094	Landside R
BK069	96095	Landside L
BK084	94622	Share knife R
BK084	94623	Share knife L

Parts to mount on landsides

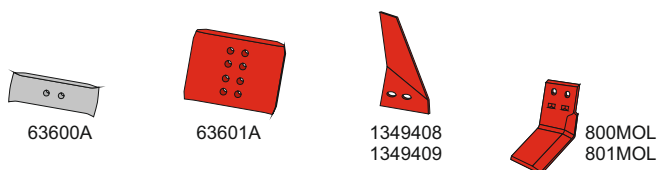

BK094	63600A	Wearing plate, rev. R&L
BK094	63601A	Wearing plate, rev. R&L
BK052	1349408	Sword coulter R
BK052	1349409	Sword coulter L
BK096	800MOL	Subsoiler blade R
BK096	801MOL	Subsoiler blade L

Parts to fit:

ØVERUM ploughs

		<u>Bolt box no.</u>	<u>Article-no.</u>	<u>Designation</u>
Skim shares and skim mouldboards				
80645		BK003	80645	Skim mouldboard R
		BK052	91803	Skim mouldboard R
80644		BK052	91804	Skim mouldboard L
		BK052	95509	Skim mouldboard R
		BK052	95510	Skim mouldboard L
81519		BK008	81519	Skim share R
		BK001	86322	Skim share R
		BK001	86323	Skim share L
86322		BK050	80644	Skim share R
		BK052	91801	Skim share R
86323		BK052	91802	Skim share L
		BK052	93055	Skim share R
		BK052	93054	Skim share L
			95509	
			95510	
			93055	
			93054	
Disc coulters				
73249			73249	Cover for disc coulters R&L
73242A			73242A	Hub disc coulters R&L
80966			80966	Cover for disc coulters R&L
80967AH			80967AH	Hub disc coulters M30R
80967AV			80967AV	Hub disc coulters M30L
72547			72547	Disc coulters 18" R&L
80662			80662	Disc coulters 20" R&L
80663			80663	Disc coulters, rippled 20" R&L



Parts to fit:

ØVERUM SM, SML and SMK ploughbodies

		<u>Bolt box no.</u>	<u>Article-no.</u>	<u>Designation</u>
Shares and points				
72633		BK122	72633	Share 14" R
71345		BK122	71345	Share 16" R
			76601	Weld-on point R
			72635	Point, steel casting R
			76601	

Parts to fit:

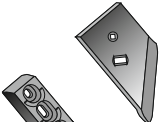
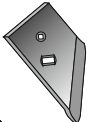
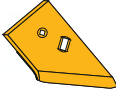
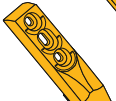
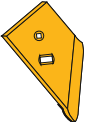
KVERNELAND Subsoiler "S" model AGROMAT

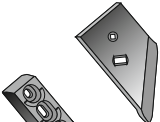
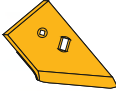
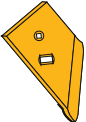
	<u>Bolt box no.</u>	<u>Article-no.</u>	<u>Designation</u>
Wings and points			
		217001320	Rev. point
		217001402L	EUROCARBIDE point
		217001402R	Wing R, wide
		217001402LC	Wing L, wide
		217001320C	Wing R, carbide coated
		217001402RC	Wing L, carbide coated
	BK044	217001402L	
	BK044	217001402R	
	BK044	217001402LC	
	BK044	217001402RC	

Parts to fit:

KVERNELAND Bonator

	<u>Bolt box no.</u>	<u>Article-no.</u>	<u>Designation</u>
Wings and points			
	BK099	131124R	Wing R
	BK099	131125R	Wing L
	BK034	337MOL	Rev. point 12 x 120 x 455







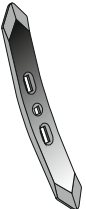

Parts to fit:

Standard Harrows and Subsoiler

	<u>Bolt box no.</u>	<u>Article-no.</u>	<u>Designation</u>
Shares and points			
	BK046	506008	Rev. point, 16 x 60 x 495
	BK046	506008-20	Rev. point, 20 x 60 x 495
	BK046	506008C	EUROCARBIDE point rev, 16 x 60 x 495
	BK046	506009	Rev. point, 15 x 55 x 410
	BK046	506009C	EUROCARBIDE point rev, 15 x 55 x 410
	BK046	506009-20	Rev. point, 13 x 55 x 410
	BK047	900863	Duck foot point, 460mm
	BK047	901MOL	Duck foot point, 310mm
	BK160	6TGL	EUROPOINT, rev. 6 x 40 x 210
		4041003057	Duck foot point, 252mm
		4878000	Universal beam

Parts to fit:

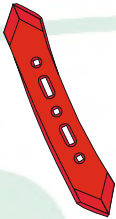
Standard Harrows and Subsoiler

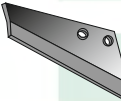
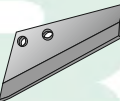
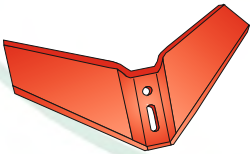
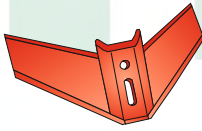
	<u>Bolt box no.</u>	<u>Article-no.</u>	<u>Designation</u>
Wings and points			
	BK034	334MOL	Rev. point, 16 x 60 x 490
	BK034	335MOL	Rev. point, 12 x 80 x 420
	BK034	336MOL	Rev. point, 12 x 100 x 420
	BK034	337MOL	Rev. point, 10 x 120 x 455
	BK034	338MOL	Rev. point, 10 x 130 x 485
	BK034	339MOL	Rev. point, 12 x 100 x 480
		HC121	Point turned R 80 x 12 x 510
		HC122	Point turned L 80 x 12 x 510
	BK021	92536 (506301)	Wing R, 8mm
	BK021	92537 (506302)	Wing L, 8mm
	BK147	500MOL	EUROWING wing 500 x 14 mm
	BK147	320MOL	EUROWING wing 320 x 12mm

Parts to fit:

US Standard Subsoiler, CASE, NEW HOLLAND

	NN101582 (33310060)	Wing point, standard 330 x 190 x 30mm
	NN10685	Point, standard 330 x 30mm
	BN90989	Duck foot point, 200mm
	C NELSON	Point 50 x 8mm

Parts to fit:

Standard Discs for Kverneland, Horsch, Fortschritt etc.

Discs		Article-no.	Designation
		331354271	Disc, notched Ø 660x6 mm <i>fits to:</i> Fortschritt
		MDU1-660	Disc, notched Ø 660x6 mm <i>fits to:</i> Kuhn 117109 Väderstad 406938 (Ø42) Vogel & Noot DSQ06609 (Ø41)
		MDU3-660-6	Disc, notched Ø 660x6 mm <i>fits to:</i> Dalbo 72387 (41x41) Rabe 64423202 (30x30) Kverneland KK121220R (40x40)
		MDU4-660-6	Disc Ø 660x6 mm <i>fits to:</i> Dalbo 72387 (41x41) Rabe 64423202 (30x30) Kverneland KK121220R (40x40) Rau RF28474
		MDU5-660-6	Disc Ø 660x6 mm <i>fits to:</i> Kuhn 117109 Väderstad 406938 (Ø42) Vogel & Noot DSQ06609 (Ø41)

Should you require a particular share hole in your 660 mm disc, please let us have details, and we will quote according.

Parts to fit:

Standard Discs for Kverneland, Horsch, Fortschritt etc.

Discs

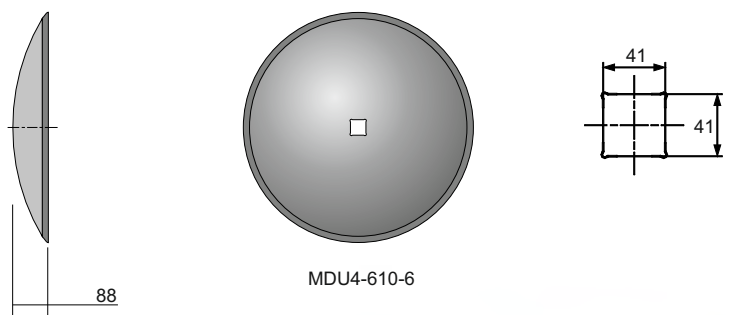
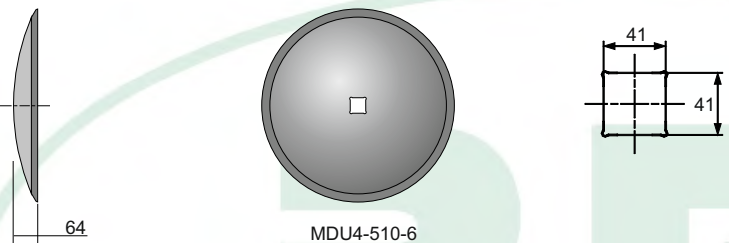
			Article-no.	Designation
 <p>MDU4-610-6</p>			MDU4-610-6	Disc Ø 610x6 mm
 <p>MDU4-510-6</p>			MDU4-510-6	Disc Ø 510x6 mm fits to: Dalbo 72388 (41x41)

Should you require a particular share hole in your 660 mm disc, please let us have details, and we will quote according.

Parts to fit:

Hub for disc coulters (Kverneland DXG etc.)

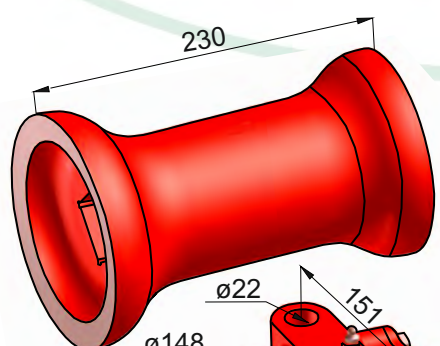
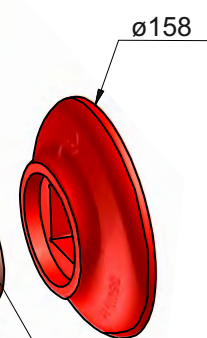
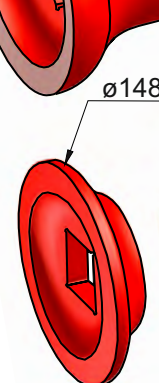
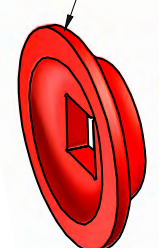









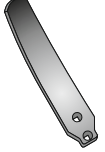



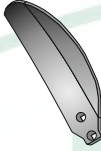



 <p>02/0551301</p>			02/0551301	Spacer th- 230-42x42
 <p>05/0558340</p>			05/0558340	Steel bearing shell 42x42
 <p>50/0551315</p>			50/0551315	Convex flange 42x42
 <p>50/0551314</p>			50/0551314	Convex flange 42x42

Parts to fit:

HORSCH Subsoiler and Standard Subsoiler

Guide boards and points

Bolt box no. Article-no. Designation

				<i>BK147</i> 34060859	Guideboard R
34060858	34060859	34060862	34060863	<i>BK147</i> 34060858	Guideboard L
				<i>BK147</i> 34060863	Guideboard R
				<i>BK147</i> 34060862	Guideboard L
				<i>BK147</i> 34182600	Side guideboard L
				<i>BK147</i> 34182700	Side guideboard R
					
34182600	34182700				
				34060855	Wing R
34060857	34060856	34060857C	34060856C	34060854	Wing L
				34060857	Wing R
				34060856	Wing L
				34060857C	EUROCARBIDE Wing R
34060855	34060854			34060856C	EUROCARBIDE Wing L
				<i>BK148</i> 34060850	EUROPOINT 80x12
34060850	34060850-15	00310915		<i>BK148</i> 34060850-15	EUROPOINT 80x15
				<i>Bk148</i> 00310915	EUROPOINT 80x15
				<i>BK148</i> 34060850C	EUROCARBIDE point 80x12
				<i>BK148</i> 34060850C-15	EUROCARBIDE point 80x15
				<i>BK148</i> 00310915C	EUROCARBIDE point 80x15
					
34060850C	34060850C-15	00310915C			
				<i>BK148</i> 00311069	EUROPOINT with plades, 80x20
00311069	MOL310979			<i>BK148</i> MOL310979	EUROPONIT 80x20

Parts to fit:

HORSCH Subsoiler and Standard Subsoiler

	Bolt box no.	Article-no.	Designation
Points			
	BK034	334MOL	Rev. point, 16 x 60 x 490
	BK034	335MOL	Rev. Point, 12 x 80 x 420
	BK034	336MOL	Rev. point, 12 x 100 x 420
	BK034	337MOL	Rev. point, 10 x 120 x 455
	BK034	338MOL	Rev. point, 10 x 130 x 485
	BK034	339MOL	Rev. point, 12 x 100 x 480

Disc coulters			
	23246106	23246102	28071304
	23010201	28071305	
			23246106 Disc coulters, concave, notched Ø455mm
			23246102 Disc coulters, concave, notched Ø460mm
			28071304 Disc coulters, concave, notched Ø460mm
			23010201 Disc coulters, flat, Ø345mm
			28071305 Disc coulters, concave, notched Ø520mm



Parts to fit:

BOURGAULT Subsoiler

Points		
	MB-200-057	Point, 57mm
	MB-200-100	Point, 100mm
	MB-200-140	Point, 140mm
	MB-200-180	Point, 180mm
	MB-200-230	Point, 230mm
	MB-200-255	Point, 255mm















Parts to fit:

KERNER Subsoiler

	<u>Bolt box no.</u>	<u>Article-no.</u>	<u>Designation</u>
Guide boards and points			
	BK049	92274	Guideboard center
	BK162	92281	EUROPOINT, 12x120x240
	BK162	92281C	EUROCARBIDE point, 12 x 120 x 240

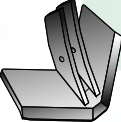
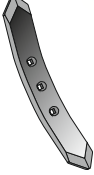
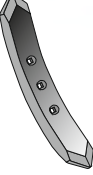
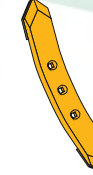
Parts to fit:

KÖCKERLING Subsoiler and Standard Subsoiler

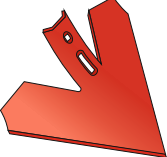
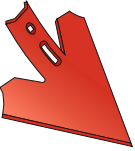
	<u>Bolt box no.</u>	<u>Article-no.</u>	<u>Designation</u>
Guide boards, wings and points			
	BK148	907020	Guideboard center, with safety catch
	BK148	506000	Guideboard R
	BK148	506001	Guideboard L
	Bk148	506046	Guideboard center
	BK148	506014	EUROPOINT, 12 x 100 x 288
	BK148	506014C	EUROCARBIDE point, 12 x 100 x 288
	BK148	506064	EUROPOINT, 12 x 80 x 288
	BK148	506064	EUROPOINT, 12 x 80 x 288
	BK148	506065	EUROPOINT, 14 x 80 x 288
	BK148	506065	EUROPOINT, 14 x 80 x 288
	BK148	506065C	EUROCARBIDE point, 14 x 80 x 288
		506025	Wing, 350mm
	BK046	506008	EUROPOINT, rev, 16 x 60 x 495
	BK046	506008C	EUROCARBIDE point rev, 16 x 60 x 495
	BK046	506008-20	EUROPOINT, rev, 20 x 60 x 495
	BK046	506009	EUROPOINT, rev, 15 x 55 x 410
	BK046	506009C	EUROCARBIDE point rev, 16 x 60 x 495
	BK047	900863	Duck foot point, 460mm
		900863	
	BK047	901MOL	Duck foot point, 310mm
		901MOL	

Did you know that...

Mølbro produce the guideboard 907020 with an open safety hook so you don't have to remove the point to change the guideboard.

Parts to fit:

LEMKEN Smaragd / Topas Harrows

Wings, points and accessories				Bolt box no.	Article-no.	Designation
				BK048	4679105	Foot - Stein 10
3374398	3374395	4679105	3374399	BK049	3374398	Guide board outer R
				BK049	3374395	Guide board center
				BK049	3374399	Guide board outer L
				BK088	3374416	Wing 10 mm R
	3374416	3374388	3374417	BK088	3374417	Wing 10 mm L
				BK088	3374418	Wing, Curved 10 mm R
	3374418	3374388-12	3374419	BK088	3374419	Wing, Curved 10 mm L
	3374420		3374421	BK088	3374420	Wing, Curved 11 mm R
				BK088	3374421	Wing, Curved 11 mm L
				BK088	3374424C-15	Wing, Curved, carbide R
3374424C-12	3374424C-15	3374392C	3374425C-15	BK088	3374425C-15	Wing, Curved, carbide L
				BK088	3374424C-12	Wing, Curved, carbide R
				BK088	3374425C-12	Wing, Curved, carbide L
				BK035	3374388	EUROPOINT 120x10
				BK035	3374388-12	EUROPOINT 120x12
				BK035	3374392C	EUROCARBIDE point 120x12
				BK035	3374392-15C	EUROCARBIDE point 120x15
		3374392-15C				

Parts to fit:

LEMKEN Thorit / Achat Harrows

Wings, points and accessories				Bolt box no.	Article-no.	Designation
				BK049	3374398	Guide board outer R
3374398	3374395	4679105	3374399	BK049	3374395	Guide board center
				BK048	4679105	Guide board center
				BK049	3374399	Guide board outer L
				BK035	3374388	EUROPOINT 120x10
	3374388	3374388-12	3374392C	BK035	3374388-12	EUROPOINT 120x12
				BK035	3374392C	EUROCARBIDE point 120x12
				BK035	3374392-15C	EUROCARBIDE point 120x15
				BK088	3374428C	Wing, Curved, carbide R
	3374428C	3374428	3374429	BK088	3374428	Wing, Curved, R
				BK088	3374429	Wing, Curved, L
				BK088	3374429C	Wing, Curved, carbide L
				BK049	3374401	Guide board center
	3374401	4679107	3374386	BK048	4679107	Foot
				BK035	3374386	EUROPOINT 80x12
				BK035	3374386C	EUROCARBIDE point 80x12

Parts to fit:

LEMKEN Harrows

Points and disc coulters

Bolt box no. Article-no. Designation

					<i>BK034</i>	334MOL	Rev. Point 16 x 60 x 490
334MOL	335MOL	336MOL	337MOL	3490466	<i>BK034</i>	335MOL	Rev. point, 12 x 80 x 420
					<i>BK034</i>	336MOL	Rev. Point, 12 x 100 x 420
					<i>BK034</i>	337MOL	Rev. point, 10 x 120 x 455
					<i>BK034</i>	338MOL	Rev. point, 10 x 130 x 485
					<i>BK034</i>	339MOL	Rev. point, 12 x 100 x 480
338MOL	339MOL	3490466				3490466	Disc coulters, concave, notched Ø625mm
						3490467	Disc coulters, concave, notched Ø625mm

Parts to fit:

LEMKEN-KOMPAKTOR Harrows

Point



3374356

BK017 3374356 Duck foot point
250 x 5

Parts to fit:

LEMKEN-Drill machines

Seeding

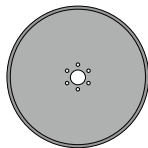









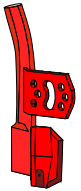
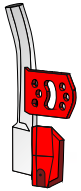
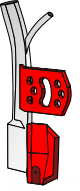
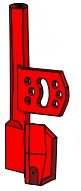
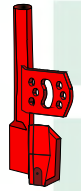

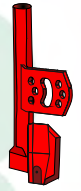
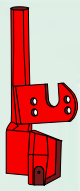
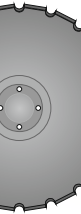
3490010

3490010 Seeding Disc, flat
Ø350mm

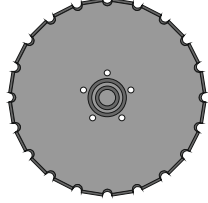
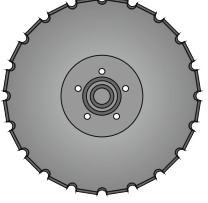
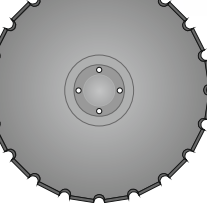
Parts to fit:

VÄDERSTAD Drill machines

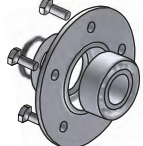









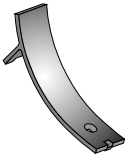





	Bolt box no.	Article-no.	Designation
Fertilizing			
		432120	Seed share, fertilizer R
		432121	Seed share, fertilizer L
		432120MOL-SF	Seed share, fertilizer R Stainless steel
		432121MOL-SF	Seed share, fertilizer L Stainless steel
432120 432121		432120MOL-SLF 432121MOL-SLF	Combo seed share, liquid fertilizer R, Stainless steel
		432121MOL-SLF	Combo seed share, liquid fertilizer R, Stainless steel
Seeding			
		432117	Seed share R
		432116	Seed share L
		432117-3	Seed share R 3mm
		432116-3	Seed share L 3mm
		499059	Bean share
		499060	Bean share
432117 432116		432119 432118	Seed share R, short slit Seed share L, short slit
		307108 307107	Seed share R Seed share L
		444687 (423787)	Disc coultter, concave, notched Ø432mm
		451793	Disc coultter, notched Ø370mm
		459608	Disc coultter, concave, notched Ø432mm
444687/423787		451371	Disc coultter, notched Ø410mm
451793		451372	Disc coultter, concave, notched Ø410mm
		466947	Disc coultter, concave, notched Ø450mm
		BK088 419998-1	Wearing plate 45x10
		BK088 419998-1C	Wearing plate 45x10
451371		BK088 419999-1	Wearing plate 80x8
		420832	Hub for disc coultter
		BK023 302300	Rev. point
		BK160 6TGL	Rev. point 6 x 40 x 210
		400703	Harrow point round ø28 x 300
419998-1		400523	
419998-1C		302300	
419999-1		400703	
400523		420832	
302300			
400703			
420832			

Parts to fit:

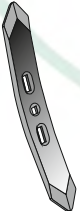
VÄDERSTAD Harrows

Bolt box no. Article-no. Designation

Wings, points and accessories

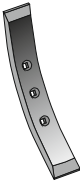
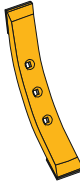
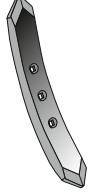
			<i>BK148</i> 452956	Guide board R	
452956	461309	452957	<i>BK148</i> 461309	Guide board L	
			<i>BK148</i> 452957	Guide board center	
				457618C	
457618	452854	452854	457618C	<i>BK048</i> 457618	
				<i>BK048</i> 452854	
				<i>BK048</i> 452854C	
				155027	
155027	155028	447150	447151	155028	
				447150	
				447151	
					
334MOL	335MOL	336MOL	337MOL	338MOL	339MOL
				<i>BK034</i> 334MOL	Rev. point, 16 x 60 x 490
				<i>BK034</i> 335MOL	Rev. point, 12 x 80 x 420
				<i>BK034</i> 336MOL	Rev. point, 12 x 100 x 420
				<i>BK034</i> 337MOL	Rev. point, 10 x 120 x 455
				<i>BK034</i> 338MOL	Rev. point, 10 x 130 x 485
				<i>BK034</i> 339MOL	Rev. point, 12 x 100 x 480
				<i>BK044</i> 201388-1	EUROPOINT R 90 x 10 x 460
201388-1	355652	355652C	447152	<i>BK044</i> 201387-1	EUROPOINT L 90 x 10 x 460
201387-1				<i>BK046</i> 355652	EUROPOINT point, rev. 19 x 57 x 460
				<i>BK046</i> 355652C	EUROCARBIDE point, rev. 19 x 57 x 460
				447152	EUROPOINT rev. 20 x 50 x 495

Did you know that...

Mølbro's universal MOL-subsoiler serie fits almost all cultivators, harrows models in Europe.

EUROCARBIDE Wearing parts ploughs

Parts to fit..

AGROLUX

EUROPOINTS coated

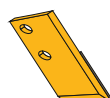

84987C
85206C

Bolt box no. Article no. Designation

BK031	84987C	EUROCARBIDE M5 point R
BK031	85206C	EUROCARBIDE M5 point L

Parts to fit..

FORTSCHRITT, FRAUGE

EUROPOINTS coated



9310MOLC



5309MOLC

BK095	9310MOLC	EUROCARBIDE M3 point R
-------	----------	------------------------

BK095	5309MOLC	EUROCARBIDE M3 point R
-------	----------	------------------------

Parts to fit..

GREGORIE-BESSON

EUROPOINTS coated



MOL332C
MOL331C

BK095	MOL332C	EUROCARBIDE M3 point R
BK095	MOL331C	EUROCARBIDE M3 point L

Parts to fit..

KUHN

Accessories coated



MOL180C
MOL181C

BK095	MOL180C	EUROCARBIDE M3 point R
BK095	MOL181C	EUROCARBIDE M3 point L

BK166	MOL200C	EUROCARBIDE M5 point R
BK166	MOL201C	EUROCARBIDE M5 point L

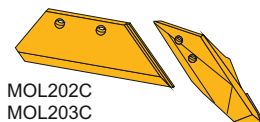

MOL202C
MOL203C

MOL200C
MOL201C

BK165	MOL202C	EUROCARBIDE M5 share 16" R
BK165	MOL203C	EUROCARBIDE M5 share 16" L

Did you know...

Mølbros uses a special developed and specified powder wire, which is welded on with six-axis welding robots to ensure maximum precision and uniformity.

EUROCARBIDE Wearing parts ploughs

Parts to fit..

KVERNELAND ploughbodies no. 6,7,8,9, 28

EUROPOINT M5 coated

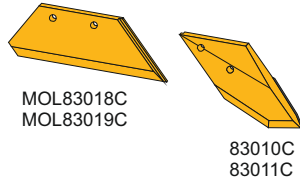

<i>BK144</i>	83010C	EUROCARBIDE M5 point R
<i>BK144</i>	83011C	EUROCARBIDE M5 point L

<i>BK111</i>	MOL83018C	EUROCARBIDE M5 16" R
<i>BK111</i>	MOL83019C	EUROCARBIDE M5 16" L

EUROCARBIDE, EUROPOINTS coated

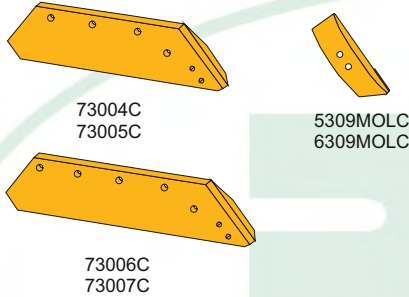

<i>BK113</i>	073004C	EUROCARBIDE share 16" R
<i>BK113</i>	073005C	EUROCARBIDE share 16" L

<i>BK114</i>	073006C	EUROCARBIDE share 18" R
<i>BK114</i>	073007C	EUROCARBIDE share 18" L

<i>BK095</i>	5309MOLC	EUROCARBIDE M3 point R
<i>BK095</i>	6309MOLC	EUROCARBIDE M3 point L

Landsides coated

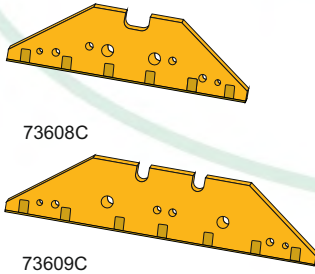

<i>BK111</i>	73608C	EUROCARBIDE,landside,short R&L
--------------	--------	--------------------------------

<i>BK111</i>	73609C	EUROCARBIDE,landside,long R&L
--------------	--------	-------------------------------

Parts to fit..

KVERNELAND ploughbodies no. 12,19 & 20,30

EUROSHARE M5 coated

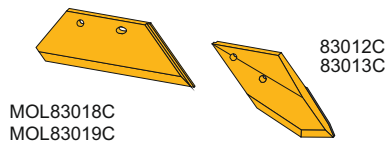

<i>BK170</i>	MOL83018C	EUROCARBID M5 share 16" R
<i>BK170</i>	MOL83019C	EUROCARBID M5 share 16" L

<i>BK144</i>	83012C	EUROCARBID M5 point R
<i>BK144</i>	83013C	EUROCARBID M5 point L

EUROCARBIDE Wearing parts ploughs

Parts to fit..

LEMKEN

Accessories coated

Bolt box no. Article no. Designation

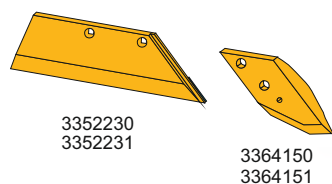

3352230
3352231

3364150
3364151

BK031 3352230 EUROCARBIDE M5 18" R
BK031 3352231 EUROCARBIDE M5 18" L

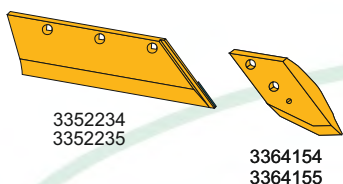

3352234
3352235

3364154
3364155

BK036 3364150 EUROCARBIDE M5 point R
BK036 3364151 EUROCARBIDE M5 point L
BK036 3364154 EUROCARBIDE M5 point R
BK036 3364155 EUROCARBIDE M5 point L

BK037 3352234 EUROCARBIDE M5 20" R
BK037 3352235 EUROCARBIDE M5 20" L

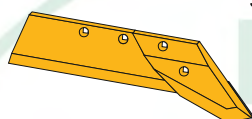

MOL2030C
MOL2031C

BK038 MOL2030C EUROCARBIDE share 18" R
BK038 MOL2031C EUROCARBIDE share 18" L

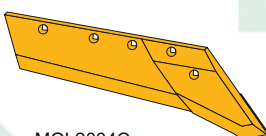

MOL2034C
MOL2035C

BK039 MOL2034C EUROCARBIDE share 20" R
BK039 MOL2035C EUROCARBIDE share 20" L

Did you know...

that the carbide coating is cohesively connected with the base material which ensures optimal durability of the coating. This means that the coating cannot fall of - it can only be worn down.

EUROCARBIDE Wearing parts ploughs

Parts to fit..

MASSEY-FERGUSON

Accessories coated

Bolt box no. Article no. Designation

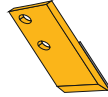

84987C
85206C

<i>BK031</i>	84987C	EUROCARBIDE M5 point R
<i>BK031</i>	85206C	EUROCARBIDE M5 point L

Parts to fit..

RABE

Accessories coated

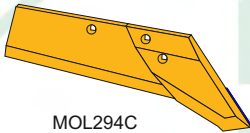

MOL294C
MOL294CL

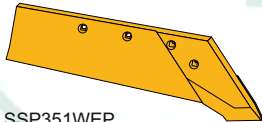

SSP351WEP
SSP351WEPL



MOL350C
MOL350LC

<i>BK037</i>	MOL294C	EUROCARBIDE share 18" R
<i>BK037</i>	MOL294CL	EUROCARBIDE share 18" L

<i>BK095</i>	MOL350C	EUROCARBIDE M3 point R
<i>BK095</i>	MOL350CL	EUROCARBIDE M3 point L

<i>BK038</i>	SSP351WEP	EUROCARBIDE share R
<i>BK038</i>	SSP351WEPL	EUROCARBIDE share L

Parts to fit..

ØVERUM

Accessories coated



92206C
92207C



84060C
85143C



94608C
94609C





<i>BK069</i>	92206C	EUROCARBIDE M3 point R
<i>BK069</i>	92207C	EUROCARBIDE M3 point L
<i>BK069</i>	84060C	EUROCARBIDE M3 point R
<i>BK069</i>	85143C	EUROCARBIDE M3 point L
<i>BK069</i>	94608C	EUROCARBIDE M3 point R
<i>BK069</i>	94609C	EUROCARBIDE M3 point L

EUROCARBIDE Wearing parts, and subsoilers

Parts to fit.. HORSCH

Wings and Points coated

Bolt box no. Article no. Designation

			34060857C	Wing, coated R
			34060856C	Wing, coated L
			BK148 34060850C	EUROCARBIDE point 85 x 12
			BK148 34060850C-15	EUROCARBIDE point 15mm 85 x 15
			BK148 00130915C	EUROCARBIDE point 15mm 85 x 15
			BK014 342MOL	EUROCARBIDE point

Parts to fit.. KERNER

Points coated

		BK162 92281C	EUROCARBIDE point 12 x 120 x 240
---	--	--------------	-------------------------------------



Parts to fit.. KVERNELAND

Wings and Points coated

				217001320C	EUROCARBIDE point
			BK044 217001402C	Wing R	
			BK044 217001402LC	Wing L	

Parts to fit.. KÖCKERLING

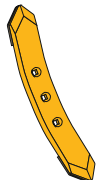
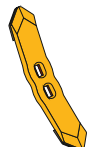
Points coated

					BK046 506008C	EUROCARBIDE point, rev, 16 x 60 x 495
					BK046 506009C	EUROCARBIDE point, rev, 15 x 55 x 410
					BK148 506014C	EUROCARBIDE point, 12 x 100 x 288.
					BK148 506064C	EUROCARBIDE point, 12 x 80 x 288.
					BK148 506065C	EUROCARBIDE point,

EUROCARBIDE Wearing parts subsoiler

Parts to fit.
LEMKEN

Wings and Points coated

Bolt box no. Article no. Designation

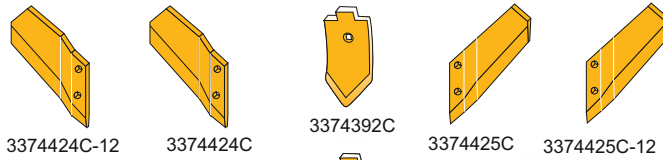

3374424C-12

3374424C

3374392C

3374425C

3374425C-12

BK088 3374424C Wing Curved, coated R
 BK088 3374425C Wing Curved, coated L
 3374424C-12 Wing Curved, coated R
 3374425C-12 Wing Curved, coated L



3374392-15C

BK035 3374392C EUROCARBIDE point 12mm
 BK035 3374392-15C EUROCARBIDE point 15mm



3374386C

BK035 3374386C EUROCARBIDE point

Parts to fit.
Standard

Points coated

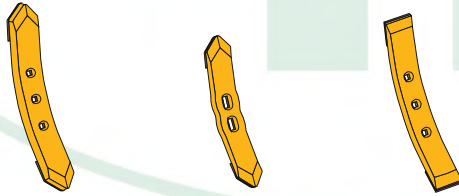

506008C

506009C

355652C

BK046 506008C EUROCARBIDE point, rev,
 16 x 60 x 495
 BK046 506009C EUROCARBIDE point, rev,
 15 x 55 x 410
 BK046 355652C EUROCARBIDE point, rev,
 19 x 57 x 460

Parts to fit.
Väderstad

Points coated



452854C



419998-1C

BK048 452854C EUROCARBID spids, 80 x 12

BK088 419998-1C Wearing plate 45x10

Disc coulters and accessories

Parts to fit:

KVERNELAND

Disc coulters and accessories

Article-no.

Designation

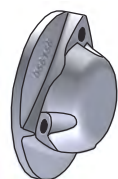

56156

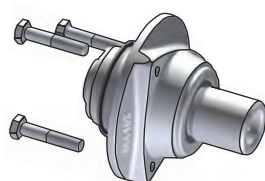

60609

56156
60609

Universal cover for hub
Hub disc coulters \varnothing 34mm

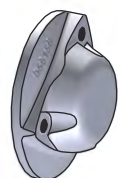

56156

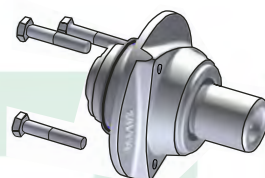

60624

56156
60624

Universal cover for hub
Hub disc coulters \varnothing 30mm

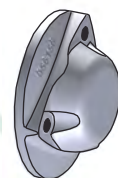

56156

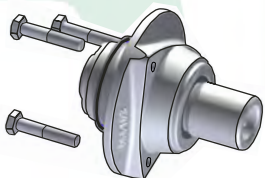

60609CA

56156
60609CA

Universal cover for hub
Hub disc coulters \varnothing 30mm

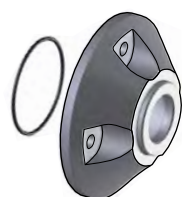

86100

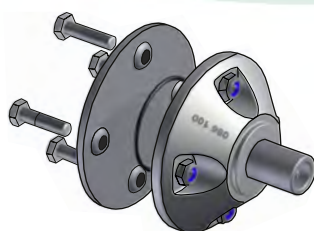

86087R

76403

Hub for disc coulters

Disc coulters and accessories

Parts to fit:

VÄDERSTAD

Disc coulters and accessories

Article-no.

Designation

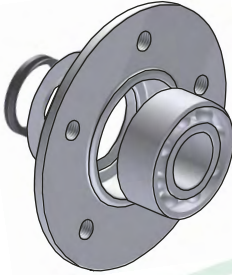

420832

420832

Hub for disc coulters

Parts to fit:

ÖVERUM

Disc coulters and accessories

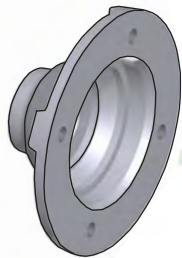

73249

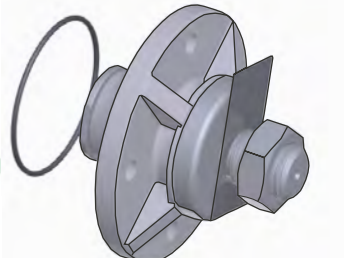

73242A

73249
73242A

Cover for hub
Hub for disc coulters
1 1/8" WGL

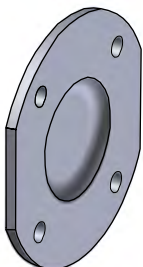

80966

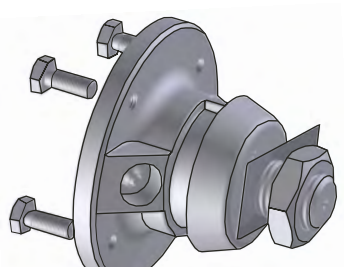

80967AH
80967AV

80966
80967AH
80967AV

Cover for hub
Hub for disc coulters M30R
Hub for disc coulters M30L

MØLBRO's bolts and nuts BK-System

<u>BK-no.</u>	<u>Bolt bags pr. Box</u>	<u>BK-no.</u>	<u>Bolt bags pr. Box</u>	<u>BK-no.</u>	<u>Bolt bags pr. Box</u>
BK001	60	BK052	60	BK112	50
BK003	60	BK053	60	BK113	40
BK004	60	BK054	60	BK114	30
BK005	25	BK055	50	BK116	10
BK006	50	BK056	25	BK118	25
BK007	60	BK057	40	BK119	60
BK008	60	BK058	60	BK121	60
BK009	60	BK059	25	BK122	60
BK010	60	BK060	25	BK123	60
BK011	25	BK062	25	Bk128	40
BK013	50	BK063	25	BK129	25
BK014	40	BK064	25	BK130	25
BK015	60	BK065	60	BK131	50
BK016	60	BK066	25	BK132	25
BK017	60	BK067	25	BK134	30
BK018	25	BK069	60	BK136	50
BK019	25	BK071	20	BK138	25
BK021	60	BK072	35	BK139	50
BK022	60	BK073	25	BK140	10
BK023	50	BK074	25	BK144	35
BK024	20	BK077	50	BK147	50
BK026	50	BK078	50	BK148	50
BK027	50	BK082	60	BK150	50
BK031	60	BK084	60	BK154	15
BK032	60	BK086	60	BK160	1
BK033	50	BK087	60	BK161	25
BK034	40	BK088	60	BK162	60
BK035	60	BK089	60	BK163	50
BK036	60	BK090	50	Bk165	50
BK037	50	BK091	50	BK166	50
BK038	40	BK092	40	BK167	60
BK039	35	BK094	60	BK170	50
BK040	40	BK095	60	BK171	25
BK041	60	BK096	60	BK172	50
BK042	50	BK097	60	BK173	50
Bk044	50	BK098	60		
Bk045	50	BK099	60		
BK046	60	BK100	50		
BK047	50	BK101	60		
BK048	60	BK103	25		
BK049	60	BK110	25		
BK050	60	BK111	60		

www.molbro.com

www.molbro.com

You can contact Mølbro 24/7

Mølbro A/S is a Danish company which has been developing and producing wearing parts for soil preparation for more than 65 years.

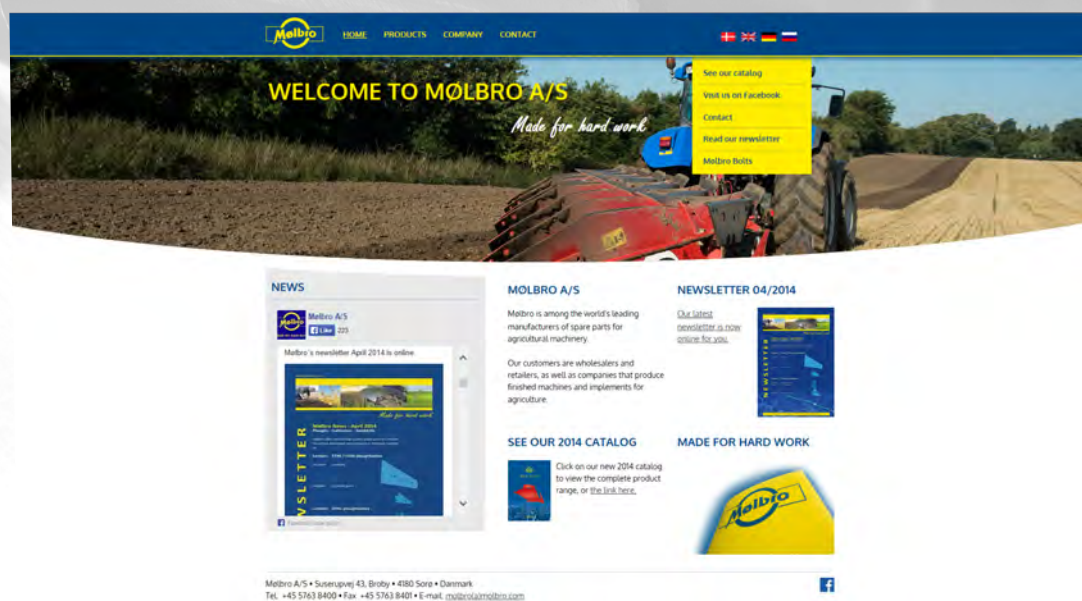

Check out **www.molbro.com** where you will find news, further information as well as all the benefits of our products.

We look forward to see you on our new homepage.

*Our idea -
Your success*



**Would you like to get more information about new products,
activities and events?
Sign up for our newsletter at www.molbro.com and follow us on
www.facebook.com/molbrodenmark.**





Mølbro A/S
Suserupvej 43
4180 Sorø
Tel. 57 63 84 00
Fax 57 63 84 01
molbro@molbro.dk

DISTRIBUTORE ESCLUSIVO PER L'ITALIA



Via Stephenson, 32/L - 20019 Settimo Milanese (MI) - ITALIA
Tel. +39 0233512210 Fax +39 023284869
email: info@rima-parts.com
www.rima-parts.com

molbro.com